

**Flush plate for concealed WC cisterns made by Geberit round - Brushed
Durabrace (23kt Gold)**













IMO

12 665 979



- cover plate 169 x 246 x 12 mm
- Mechanical flush plate with manual flush buttons
- For 2-volume flushing system
- Includes mounting frame, actuator rods and fastening material
- Sound-absorbing push rods, tool-free fast adjustment
- Compatible with all Geberit Sigma series cisterns from 2001 onwards

Fits: IMO, LULU, MADISON, TARA, LISSÉ, VAIA, META, CYO

	Brushed Durabrace (23kt Gold)	12 665 979-28
	Chrome	12 665 979-00
	Brushed Platinum	12 665 979-06
	Platinum	12 665 979-08
	Durabrace (23kt Gold)	12 665 979-09
	Dark Chrome	12 665 979-19
	Light Gold	12 665 979-26
	Brushed Light Gold	12 665 979-27
	Matte Black	12 665 979-33
	Brushed Bronze	12 665 979-42
	Brushed Champagne (22kt Gold)	12 665 979-46
	Champagne (22kt Gold)	12 665 979-47
	Brushed Chrome	12 665 979-93
	Brushed Dark Platinum	12 665 979-99

Flush plate for concealed WC cisterns made by Geberit round - Brushed
Durabronze (23kt Gold)

IMO

12 665 979

mm [inches]

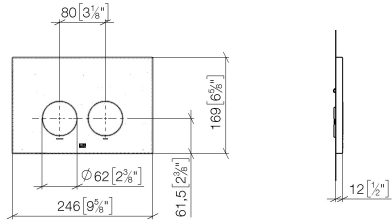

Flush plate for concealed WC cisterns made by Geberit round - Brushed
Durabronze (23kt Gold)

IMO

12 665 979
Parts for other
finishes can be found
here: Chrome

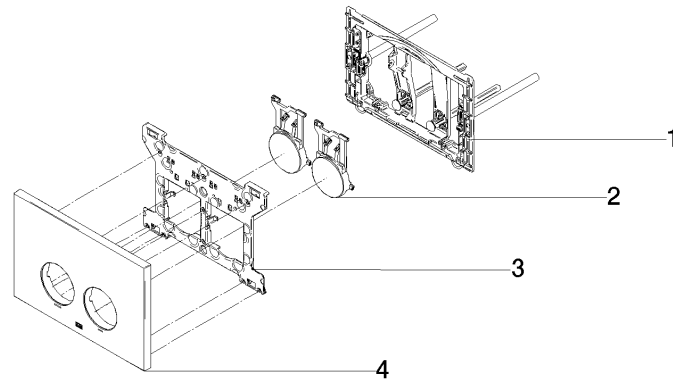

Spare parts list

No.	Item Number	Name	Quantity used	Delivery time
1	90 28 01 030 00 90	base	1	2
2	90 20 97 100 00-28	button	2	20
3	90 28 10 212 00 90	base	1	2
4	90 11 97 012 00-28	cover	1	20