







20 713 671



- 165mm projection
- fixed spout
- rectangular, air-enriched flow
- height of mixer 220 mm
- height up to aerator 177 mm
- hole diameter valve 32 mm
- hole diameter spout 35 mm
- rosette 60 x 60 mm
- 2x screw-in M 10 x 1 pressure hose, leak-tested
- max. flow 4.6 l/min
- lead-free
- This product can help a building meet the requirements of Green Building Rating Systems, e.g. LEED®, BREEAM®, DGNB

Only suitable for basins with an overflow.

	Brushed Light Gold	20 713 671-27
	Chrome	20 713 671-00
	Brushed Platinum	20 713 671-06
	Dark Chrome	20 713 671-19
	Matte Black	20 713 671-33
	Brushed Chrome	20 713 671-93
	Brushed Dark Platinum	20 713 671-99

Recommended miscellaneous



High pressure hoses -
● 2x 3/8" x 1/2" x 500mm high pressure hose

12 506 970 90

20 713 671

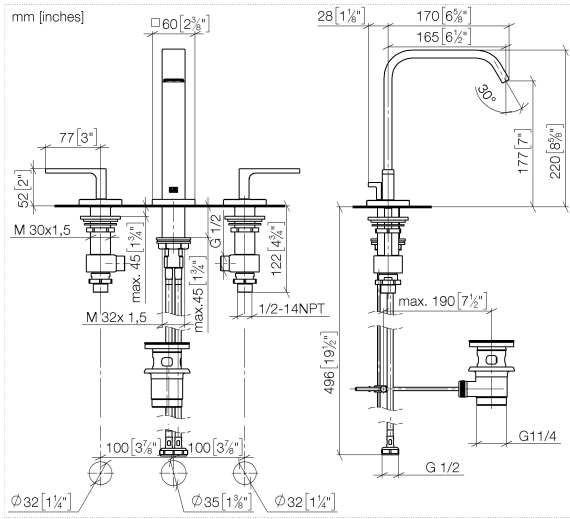

Flow rate chart





IMO Three-hole basin mixer with pop-up waste - Brushed Light Gold

IMO

20 713 671



Spare parts list