









20 713 819



- 168mm projection
- pivotable spout 360°
- circular, air-enriched flow
- height of mixer 280 mm
- height up to aerator 191 mm
- hole diameter valve 32 mm
- hole diameter spout 35 mm
- rosette Ø 60 mm
- max. flow 5.7 l/min
- lead-free
- This product can help a building meet the requirements of Green Building Rating Systems, e.g. LEED®, BREEAM®, DGNB
- WRAS 2312068

Only suitable for basins with an overflow.

	Champagne (22kt Gold)	20 713 819-47
	Chrome	20 713 819-00
	Brushed Platinum	20 713 819-06
	Platinum	20 713 819-08
	Dark Chrome	20 713 819-19
	Brushed Durabronze (23kt Gold)	20 713 819-28
	Brushed Bronze	20 713 819-42
	Brushed Champagne (22kt Gold)	20 713 819-46
	Brushed Dark Platinum	20 713 819-99

Recommended miscellaneous



- High pressure hoses -**
 ● 2x 3/8" x 1/2" x 500mm high pressure hose

12 506 970 90

20 713 819

mm [inches]

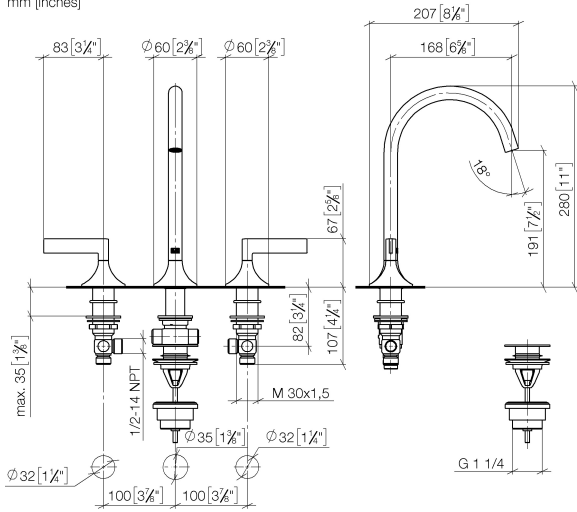

Flow rate chart

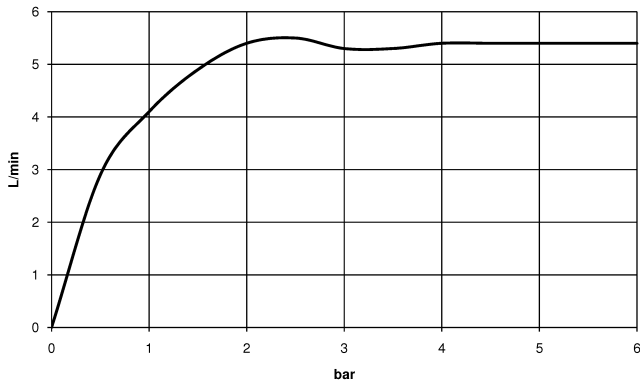

Codes & Standards

DIN 4109

Executive Order
no. 1007

ISO 3822

Scottish Water
Byelaws

UK Water Supply
Regulations

Ü-Zeichen



VAIA Three-hole basin mixer with pop-up waste - Champagne (22kt Gold)

VAIA

20 713 819

Certificates

GDV_0400

LGA_29

WRAS_2312

20 713 819

Product version from 3/13/2017

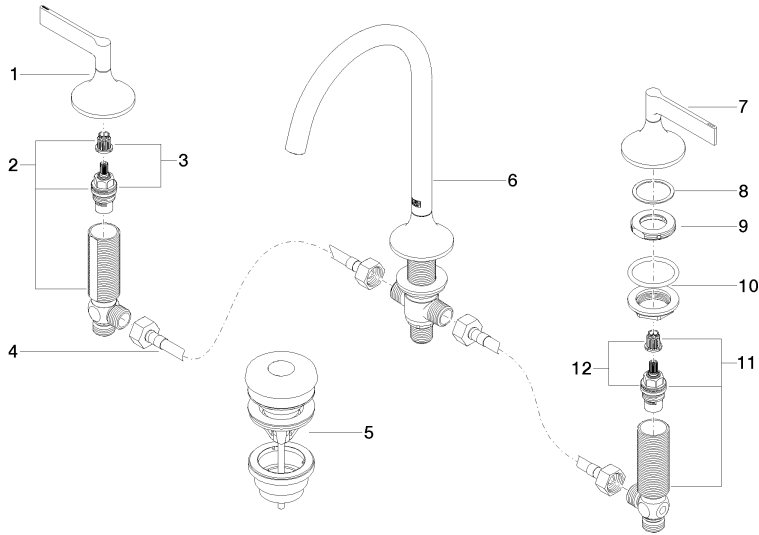



VAIA Three-hole basin mixer with pop-up waste - Champagne (22kt Gold)

VAIA

20 713 819

Spare parts list

Product version from 3/13/2017

No.	Item Number	Name	Quantity used	Delivery time
	90 20 80 013 00-47	handle (hot)	15	30