

**VAIA Two-hole bath mixer for free-standing assembly with hand shower set -  
Champagne (22kt Gold)**

VAIA

25 943 819



- spout: circular, air-enriched flow
  - max. flow 24.6 l/min at 3 bar flow pressure
  - Hand shower: COMPACT RAIN, max. flow rate 6.8 l/min (at 3 bar)
  - hand shower with anti-scale system
  - 221mm projection
  - pivotable spout 360°
  - rotary diverter for bath/shower
  - total height 920 mm
  - stand pipes height 628 mm
  - height up to aerator 816 mm
  - slide-on rosettes Ø 100 mm
  - gauge 150 mm
  - metal shower hose 1250mm with integrated anti-twist protection
  - pivotable shower holder on the right foot
  - WRAS 240502008, 1802014
- Intrinsic protection against back flow.**

Intrinsic protection against back flow.

	Champagne (22kt Gold)	25 943 819-47
	Chrome	25 943 819-00
	Brushed Platinum	25 943 819-06
	Platinum	25 943 819-08
	Dark Chrome	25 943 819-19
	Brushed Durabronze (23kt Gold)	25 943 819-28
	Brushed Bronze	25 943 819-42
	Brushed Champagne (22kt Gold)	25 943 819-46
	Brushed Dark Platinum	25 943 819-99

**Required miscellaneous**



- Concealed floor mounting -**
- max. recess depth 160 mm
  - min. recess depth 80 mm

35 944 970 90

**VAIA Two-hole bath mixer for free-standing assembly with hand shower set -  
Champagne (22kt Gold)**

VAIA

25 943 819  
mm [inches]

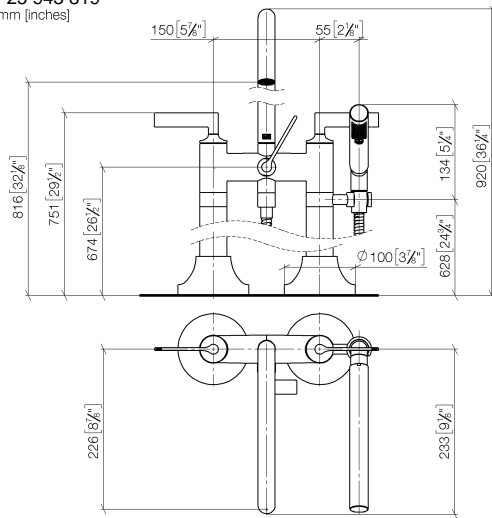

**Flow rate chart**



**Certificates**

Belgauqa\_22\_276\_2 LGA\_29294.  
7\_2.

WRAS\_240502008.

VAIA Two-hole bath mixer for free-standing assembly with hand shower set -  
Champagne (22kt Gold)

VAIA

25 943 819

