









26 632 360



- shower with fixed riser projection 420mm
- overhead shower: rain flow
- rain shower Ø 200 mm
- max. rainshower flow 14 l/min
- Function from: 8 l/min
- rotary diverter for fixed-riser shower/hand shower
- height of fittings up to top edge of elbow 1180mm
- height of fittings up to rain shower (bottom edge) 1009mm
- rosette for shower holder Ø 66mm
- rosette for wall mounting Ø 70mm
- rosette for shower mixer Ø 60mm
- gauge 150 mm - 13 mm
- metal shower hose 1250mm with integrated anti-twist protection
- 1/2" connection
- Pipe diameter 20 mm
- This product can help a building meet the requirements of Green Building Rating Systems, e.g. LEED®, BREEAM®, DGNB
- WRAS 2204012

This article does not include a hand shower!

Intrinsic protection against back flow.

		26 632 360-43
	Chrome	26 632 360-00
	Brushed Platinum	26 632 360-06
	Platinum	26 632 360-08
	Durabronze (23kt Gold)	26 632 360-09
	Brushed Durabronze (23kt Gold)	26 632 360-28
		26 632 360-39
	Brushed Bronze	26 632 360-42
	Brushed Bronze	26 632 360-42 0050
	Brushed Dark Platinum	26 632 360-99

26 632 360

mm [inches]

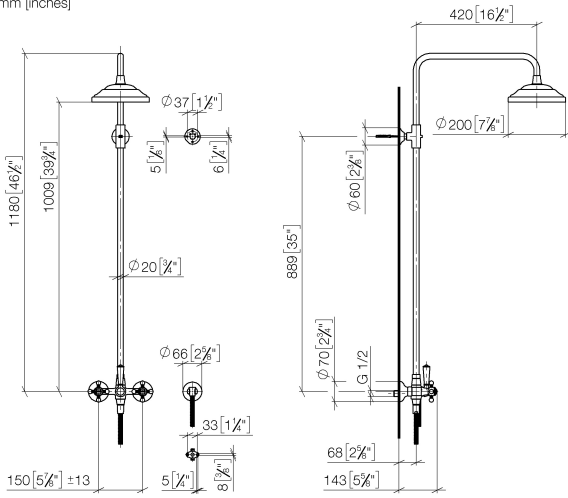

Flow rate chart

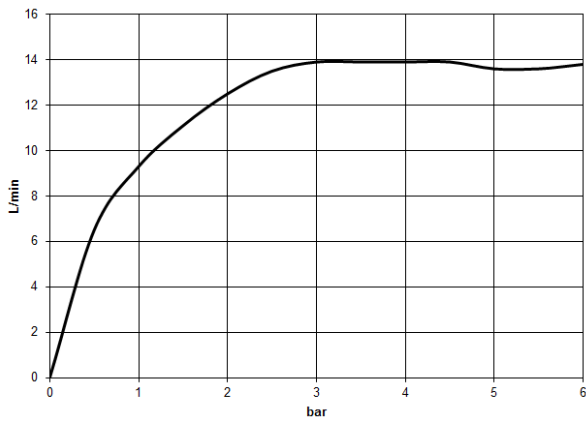

Codes & Standards

DIN 4109

ISO 3822

Ü-Zeichen



MADISON Showerpipe with shower mixer without hand shower -

MADISON

26 632 360

Certificates

LGA_29

26 632 360

Parts for other finishes can be found here: [Chrome](#)

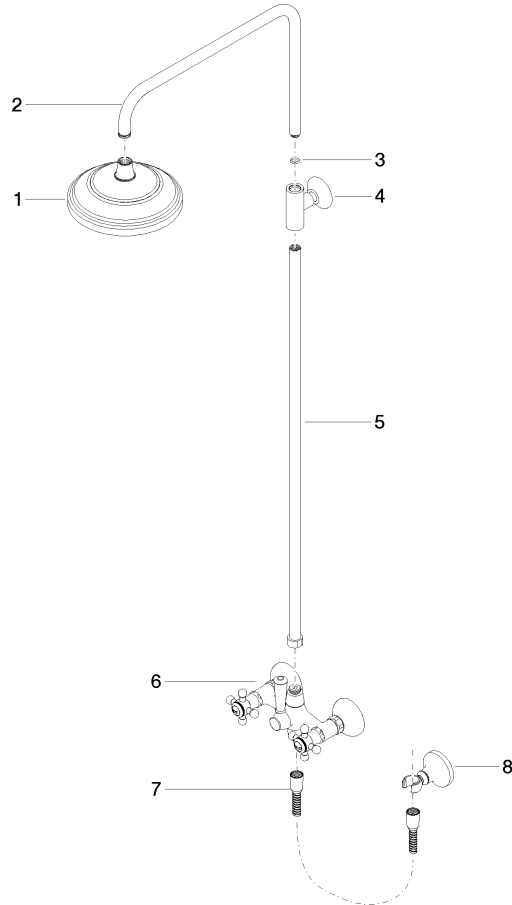



Spare parts list