







33 500 670



- 130mm projection
- fixed spout
- rectangular, air-enriched flow
- height of mixer 154 mm
- height up to aerator 80 mm
- hole diameter 35 mm
- 2x screw-in M 10 x 1 pressure hose, leak-tested
- max. flow 7 l/min
- lead-free
- This product can help a building meet the requirements of Green Building Rating Systems, e.g. LEED®, BREEAM®, DGNB
- WRAS 240202005

Only suitable for basins with an overflow.

	Brushed Platinum	33 500 670-06
	Chrome	33 500 670-00
	Platinum	33 500 670-08
	Brushed Durabronze (23kt Gold)	33 500 670-28
	Brushed Chrome	33 500 670-93
	Brushed Dark Platinum	33 500 670-99

33 500 670

mm [inches]

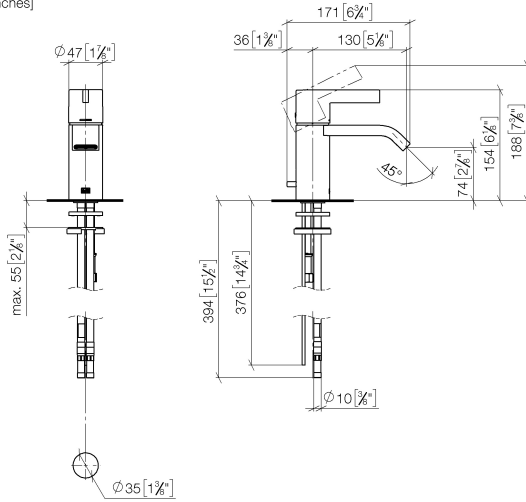

**Flow rate chart**

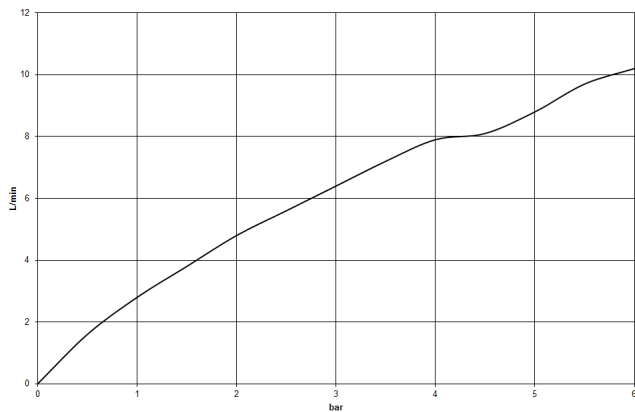

**Codes & Standards**

DIN 4109

EN 817

Executive Order  
no. 1007

ISO 3822

Scottish Water  
Byelaws

UK Water Supply  
Regulations

Ü-Zeichen

VA-Zeichen



IMO Single-lever basin mixer with pop-up waste - Brushed Platinum

IMO

33 500 670

Certificates

GDV\_0400

LGA\_19

WRAS\_240202

WRAS\_1806

ETA\_19

33 500 670

Product version up to 10/10/2018

Product version from 10/10/2018 to 5/10/2021

**Product version from 5/10/2021**

Parts for other finishes can be found here: [Chrome](#)

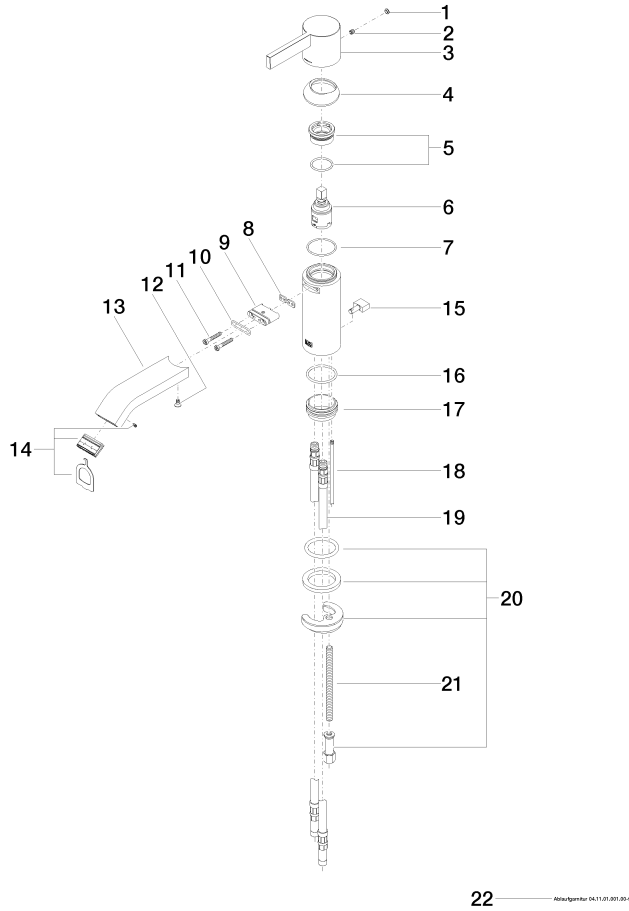



## IMO Single-lever basin mixer with pop-up waste - Brushed Platinum

IMO

33 500 670

### Spare parts list

Product version up to 10/10/2018

Product version from 10/10/2018 to 5/10/2021

#### **Product version from 5/10/2021**

No.	Item Number	Name	Quantity used	Delivery time
	90 31 20 087 00-06	plug	24	10