

**Concealed single-lever mixer with cover plate - Brushed Champagne (22kt Gold)**











IMO

36 060 670



- cover plate 80 x 80 mm
- WRAS 2107016

Fits: IMO, MEM, CL.1, CYO

|   |                               |               |
|---|-------------------------------|---------------|
|    | Brushed Champagne (22kt Gold) | 36 060 670-46 |
|    | Chrome                        | 36 060 670-00 |
|    | Brushed Platinum              | 36 060 670-06 |
|    | Platinum                      | 36 060 670-08 |
|    | Dark Chrome                   | 36 060 670-19 |
|    | Brushed Light Gold            | 36 060 670-27 |
|    | Brushed Durabrass (23kt Gold) | 36 060 670-28 |
|    | Matte Black                   | 36 060 670-33 |
|   | Champagne (22kt Gold)         | 36 060 670-47 |
|  | Brushed Chrome                | 36 060 670-93 |
|  | Brushed Dark Platinum         | 36 060 670-99 |

**Required miscellaneous**



- Concealed wall-mounted single-lever mixer -** 35 860 970 90
- max. recess depth 95 mm
  - min. recess depth 80 mm

Concealed single-lever mixer with cover plate - Brushed Champagne (22kt Gold)

IMO

36 060 670  
mm [inches]

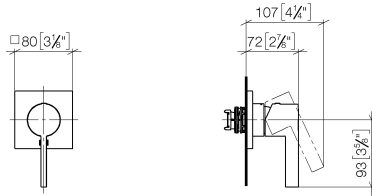

Certificates

LGA\_29905.

36 060 670

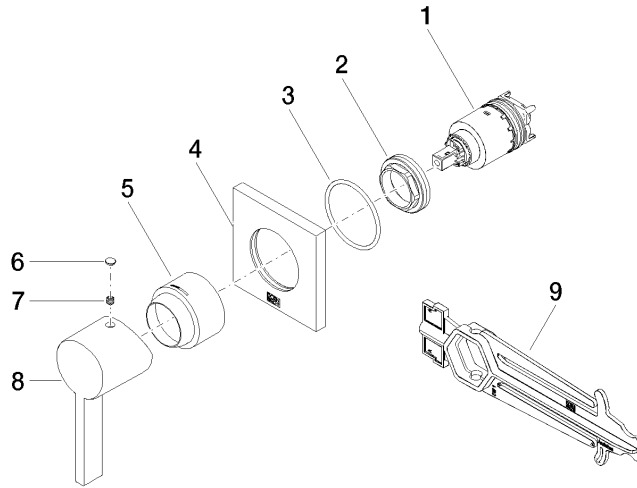

### Spare parts list

| No. | Item Number        | Name      | Quantity used | Delivery time |
|-----|--------------------|-----------|---------------|---------------|
| 1   | 90 15 05 064 01 90 | cartridge | 1             | 2             |
| 2   | 09 24 04 105 90    | nut       | 1             | 2             |
| 3   | 90 14 10 049 00 90 | seal      | 1             | 2             |
| 4   | 09 27 78 048-46    | rosette   | 1             | 30            |
| 5   | 09 11 02 530-46    | cover     | 1             | 30            |
| 6   | 90 31 20 087 00-46 | plug      | 1             | 30            |
| 7   | 90 31 11 112 00 90 | pin       | 1             | 2             |
| 8   | 09 20 67 004-46    | handle    | 1             | 30            |
| 9   | 90 30 09 064 00 90 | key       | 1             | 2             |