









MEM Concealed two-way diverter - Brushed Durabross (23kt Gold)

MEM

36 200 782



- rotary diverter
- rosette 60 x 60 mm
- WRAS 2307045

	Brushed Durabross (23kt Gold)	36 200 782-28
	Chrome	36 200 782-00
	Brushed Platinum	36 200 782-06
	Platinum	36 200 782-08
	Dark Chrome	36 200 782-19
	Brushed Champagne (22kt Gold)	36 200 782-46
	Champagne (22kt Gold)	36 200 782-47
	Brushed Dark Platinum	36 200 782-99

Required miscellaneous



- Concealed two-way diverter -** 35 202 970 90
- max. recess depth 160 mm
 - min. recess depth 115 mm

36 200 782

mm [inches]

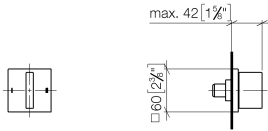

Flow rate chart

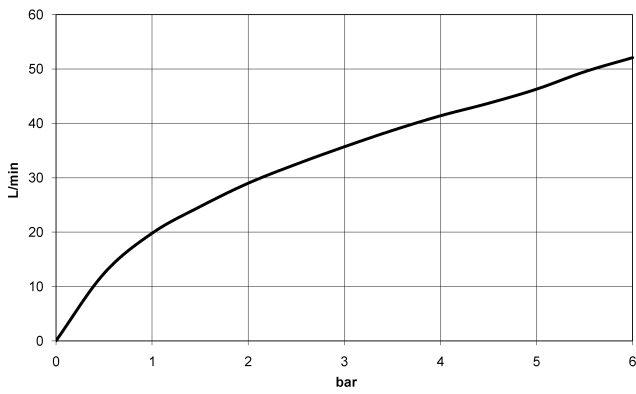

Codes & Standards

DIN 4109

ISO 3822

Scottish Water
Byelaws

UK Water Supply
Regulations

Ü-Zeichen



MEM Concealed two-way diverter - Brushed Durabross (23kt Gold)

MEM

36 200 782

Certificates

WRAS_2307

LGA_38

36 200 782

Product version from 4/1/2022

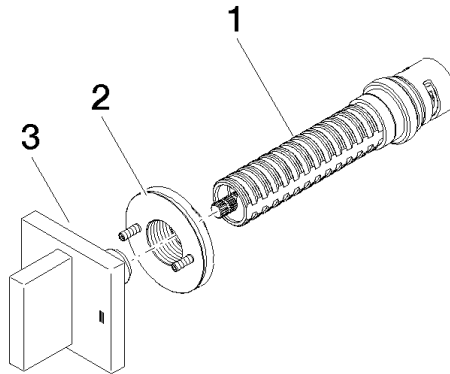



MEM Concealed two-way diverter - Brushed Durabrass (23kt Gold)

MEM

36 200 782

Spare parts list

Product version from 4/1/2022

No.	Item Number	Name	Quantity used	Delivery time
	90 90 03 304 10 90	diverter	3	2