







## CL.1 Concealed two-way diverter - Chrome

---

36 201 705 Product version from 4/1/2022



- rotary diverter
- rosette 60 x 60 mm
- WRAS

	Chrome	36 201 705-00
	Brushed Platinum	36 201 705-06
	Dark Chrome	36 201 705-19
	Brushed Champagne (22kt Gold)	36 201 705-46
	Champagne (22kt Gold)	36 201 705-47
	Brushed Dark Platinum	36 201 705-99

### Required miscellaneous

---



- Concealed two-way diverter -** 35 202 970 90
- max. recess depth mm
  - min. recess depth mm

## CL.1 Concealed two-way diverter - Chrome

36 201 705 Product version from 4/1/2022

mm [inches]

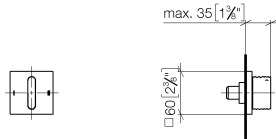

### Flow rate chart

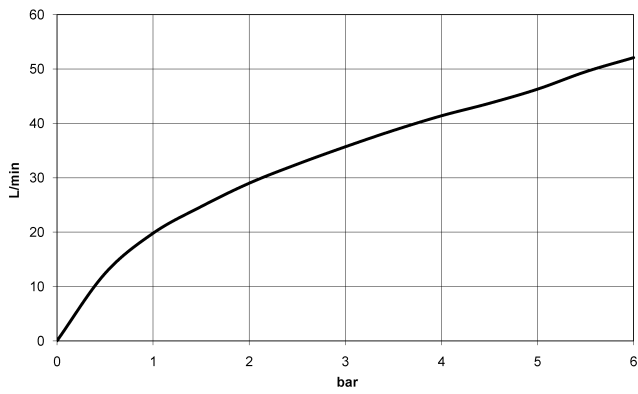

### Codes & Standards

DIN 4109

ISO 3822

Scottish Water  
Byelaws

UK Water Supply  
Regulations

### Ü-Zeichen



## CL.1 Concealed two-way diverter - Chrome

---

36 201 705 Product version from 4/1/2022

### Certificates

---

LGA\_38

WRAS\_2307

**CL.1 Concealed two-way diverter - Chrome**

36 201 705 Product version from 4/1/2022

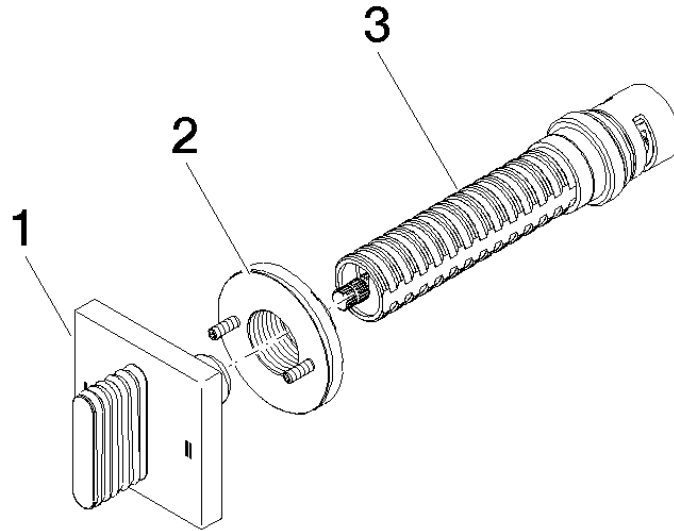

**Spare parts list**

No.	Item Number	Name	Quantity used	Delivery time
1	90 20 70 055 08-00	handle	1	10
2	90 21 02 181 00 90	disc	1	2
3	90 90 03 304 10 90	diverter	1	2