













36 513 979



- AQUAPRESSURE FLOW, max. flow rate 10 l/min (at 3 bar)
- water jet adjustable
- cover plate 240 x 60 mm
- 1/2" connection
- WRAS 2005003

Fits: IMO, LULU, MADISON, MEM, TARA, CL.1, LISSÉ, VAIA, META, CYO

	Brushed Chrome	36 513 979-93
	Chrome	36 513 979-00
	Brushed Platinum	36 513 979-06
	Platinum	36 513 979-08
	Dark Chrome	36 513 979-19
	Light Gold	36 513 979-26
	Brushed Light Gold	36 513 979-27
	Brushed Durabronze (23kt Gold)	36 513 979-28
	Matte Black	36 513 979-33
	Brushed Bronze	36 513 979-42
	Brushed Champagne (22kt Gold)	36 513 979-46
	Champagne (22kt Gold)	36 513 979-47
	Brushed Dark Platinum	36 513 979-99

**Required miscellaneous**



- Concealed wall installation box - 35 206 970 90**
- max. recess depth 175 mm
  - min. recess depth 100 mm

36 513 979

mm [inches]

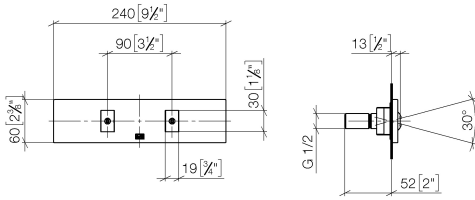

**Flow rate chart**



**Trajectory diagram**

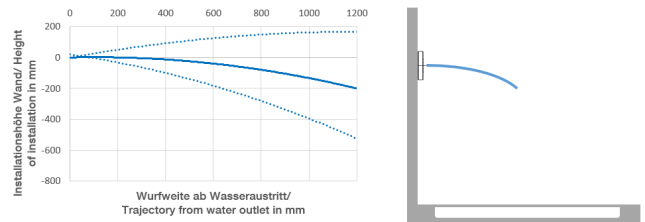

**Certificates**

LGA\_29335.

WRAS\_2005003.

36 513 979

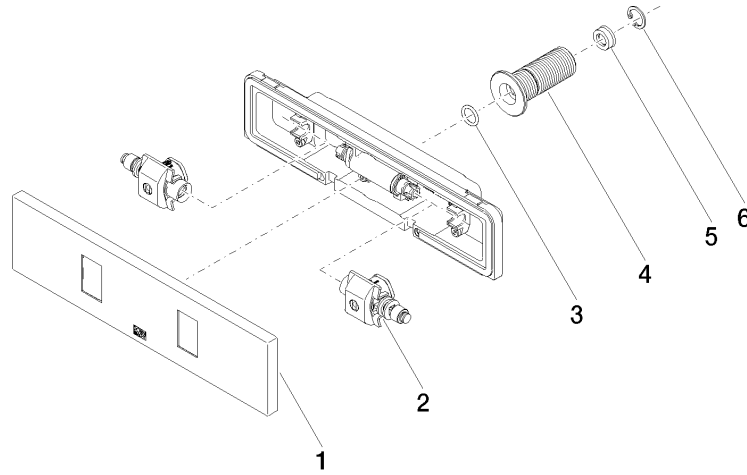

### Spare parts list

No.	Item Number	Name	Quantity used	Delivery time
1	90 27 99 002 00-93	insert	1	20
2	90 31 10 013 00 90	insert	1	2
3	09 14 10 003 90	seal	1	2
4	09 24 05 015 90	nipple	1	2
5	09 23 01 134 90	flow reducer	1	2
6	09 16 01 014 90	ring	1	2