

**WATER BAR Concealed body spray - Brushed Dark Platinum**

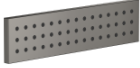











IMO

36 527 979



- HORIZONTAL RAIN, max. flow rate 9 l/min (at 3 bar)
- with anti-scale system
- cover plate 240 x 60 mm
- 1/2" connection

Fits: IMO, LULU, MADISON, MEM, TARA, CL.1, LISSÉ, VAIA, META, CYO

	Brushed Dark Platinum	36 527 979-99
	Chrome	36 527 979-00
	Brushed Platinum	36 527 979-06
	Platinum	36 527 979-08
	Dark Chrome	36 527 979-19
	Light Gold	36 527 979-26
	Brushed Light Gold	36 527 979-27
	Brushed Durabronze (23kt Gold)	36 527 979-28
	Matte Black	36 527 979-33
	Brushed Bronze	36 527 979-42
	Brushed Champagne (22kt Gold)	36 527 979-46
	Champagne (22kt Gold)	36 527 979-47
	Brushed Chrome	36 527 979-93

**Required miscellaneous**



- Concealed wall installation box - 35 206 970 90**
- max. recess depth 173 mm
  - min. recess depth 100 mm

**Recommended miscellaneous**



- xGRID Attachment set for integrating in the dry wall construction - 12 340 970 90**

**Required miscellaneous**



- xGRID Installation track 555 mm - 12 360 970 90**

36 527 979

mm [inches]

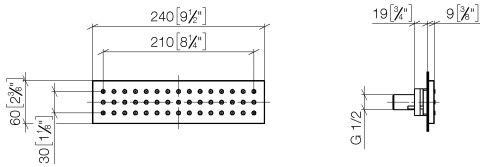

**Flow rate chart**



**Certificates**

LGA\_38672.

36 527 979

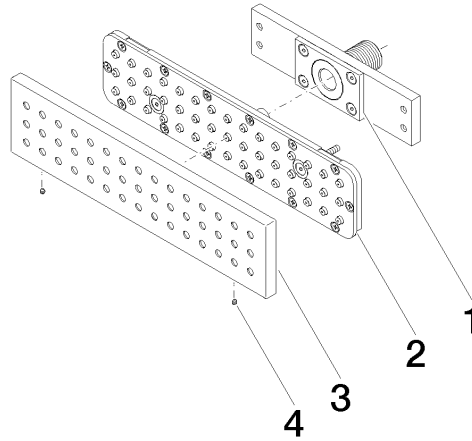

### Spare parts list

No.	Item Number	Name	Quantity used	Delivery time
1	90 11 02 137 00 90	connection	1	2
2	90 11 02 332 01-00	insert	1	10
3	09 27 99 001-99	rosette	1	30
4	09 31 11 006 90	pin	2	2