











**META Wall-mounted single-lever basin mixer without pop-up waste - Brushed Chrome**

META

36 860 660



- 190mm projection
- fixed spout
- circular, air-enriched flow
- hole diameter spout 37 mm
- hole diameter single-lever mixer 57 mm
- rosette for spout Ø 55mm
- rosette for mixer Ø 78mm
- max. flow 5.7 l/min
- lead-free
- This product can help a building meet the requirements of Green Building Rating Systems, e.g. LEED®, BREEAM®, DGNB
- WRAS 2107018

	Brushed Chrome	36 860 660-93
	Chrome	36 860 660-00
	Brushed Platinum	36 860 660-06
	Dark Chrome	36 860 660-19
	Light Gold	36 860 660-26
	Brushed Light Gold	36 860 660-27
	Matte Black	36 860 660-33
	Brushed Bronze	36 860 660-42
	Brushed Champagne (22kt Gold)	36 860 660-46
	Champagne (22kt Gold)	36 860 660-47
	Brushed Dark Platinum	36 860 660-99

36 860 660  
mm [inches]

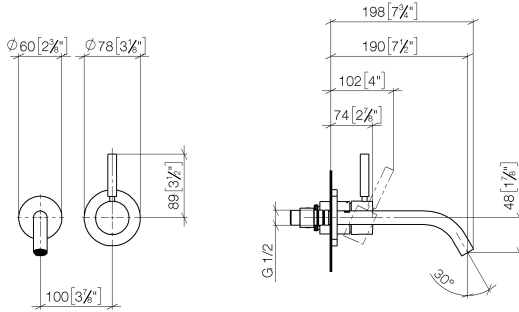

Flow rate chart



Trajectory diagram

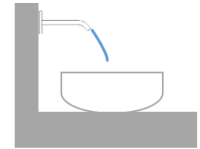
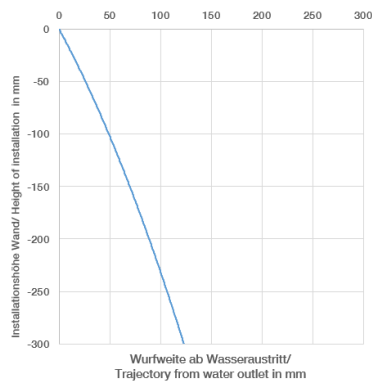

Certificates

DVGW\_DW- WRAS\_2107018. LGA\_29898.  
6512DN0435.

36 860 660

Parts for other  
finishes can be found  
here: [Chrome](#)

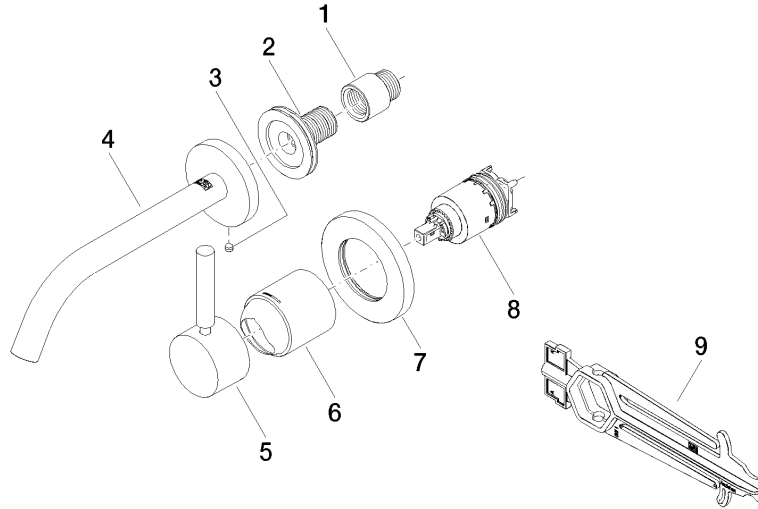

### Spare parts list

No.	Item Number	Name	Quantity used	Delivery time
1	09 24 03 072 10 90	nipple	1	2
2	90 24 03 280 00 90	nipple	1	2
3	09 31 11 112 90	pin	1	60
4	90 28 22 323 00-93	spout	1	20
5	90 20 66 007 00-93	handle	1	20
6	09 11 02 288-93	cover	1	20
7	90 27 62 011 00-93	rosette	1	20
8	90 15 05 064 01 90	cartridge	1	2
9	90 30 09 064 00 90	key	1	2