







**CL.1 Wall-mounted single-lever basin mixer without pop-up waste - Chrome**

CL.1

36 860 705 Product version from 7/1/2023



- 198mm projection
- fixed spout
- rectangular spray pattern with 40 individual jets
- hole diameter spout 37 mm
- hole diameter single-lever mixer 57 mm
- rosette 80 x 80 mm
- max. flow 4.5 l/min
- lead-free
- This product can help a building meet the requirements of Green Building Rating Systems, e.g. LEED®, BREEAM®, DGNB

	Chrome	36 860 705-00
	Brushed Platinum	36 860 705-06
	Dark Chrome	36 860 705-19
	Brushed Champagne (22kt Gold)	36 860 705-46
	Champagne (22kt Gold)	36 860 705-47
	Brushed Dark Platinum	36 860 705-99

**Required miscellaneous**



**Concealed wall-mounted single-lever mixer on right -** 35 816 970 90  
 •NOTE: Not suitable for concealed installation. Connection by means of angle valves, mounted with screws to back wall.

**Required miscellaneous**



**Concealed wall-mounted single-lever mixer -** 35 860 970 90  
 •max. recess depth mm  
 •min. recess depth mm  
 •mixer can be placed above, to the left or to the right of the spout.

36 860 705 Product version from 7/1/2023

mm [inches]

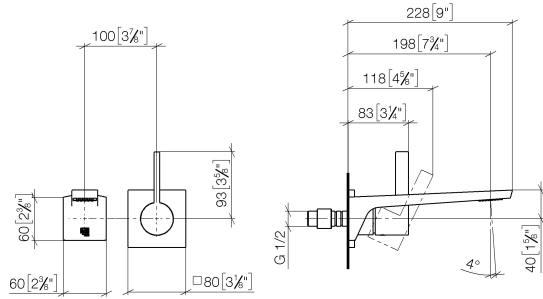

**Flow rate chart**

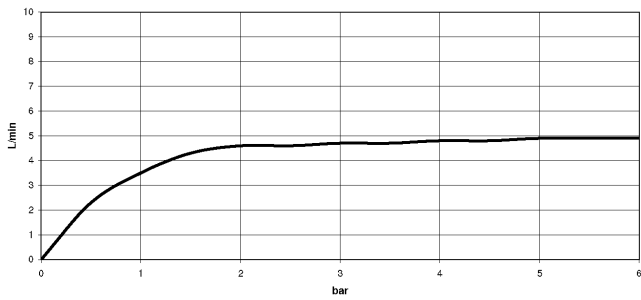

**Codes & Standards**

DIN 4109

EN 817

ISO 3822

NSF372

NSF61

Ü-Zeichen



## CL.1 Wall-mounted single-lever basin mixer without pop-up waste - Chrome

CL.1

36 860 705 Product version from 7/1/2023

### Certificates

---

IAPMO\_N-4976

DVGW\_DW-  
6512DN0

IAPMO\_6397

LGA\_29

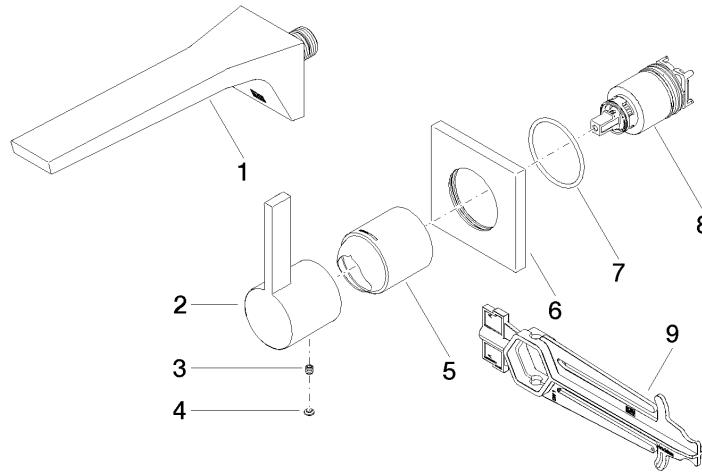

**Spare parts list**

No.	Item Number	Name	Quantity used	Delivery time
1	13 800 705-00	CL.1 Wall-mounted basin spout without pop-up waste - Chrome	1	2
2	09 20 70 050-00	handle	1	10
3	90 31 11 030 00 90	pin	1	2
4	90 31 20 087 00-00	plug	1	10
5	09 11 02 288-00	cover	1	10
6	09 27 78 039-00	rosette	1	10
7	90 14 10 049 00 90	seal	1	2
8	90 15 05 064 01 90	cartridge	1	2
9	90 30 09 064 00 90	key	1	2