







SERENITY SKY+ Rain panel for recessed ceiling installation with light - Dark Chrome

41 781 979



- exposed trim parts
 - Rain panel with 5 different flow modes
 - Rain panel, 600 x 420 mm
 - PURIFY RAIN, 175 x 175 mm, max. flow rate 10 l/min (at 3 bar)
 - FULL RAIN, 455 x 315 mm, max. flow rate 14 l/min (at 3 bar)
 - LAMINAR FLOW, max. flow rate 10 l/min (at 3 bar)
 - AQUAPRESSURE FLOW, max. flow rate 9.4 l/min (at 3 bar)
 - COOL MIST, max. flow rate 1 l/min (at 3 bar)
 - min. recess depth 150 mm
 - weight 15kg
 - feed pipe (hot/cold): 2x DN 20
 - with anti-scale system
 - Recommended control element: xTool
 - 24V DC (CV)
 - ZigBee Light Link RGBW controller
 - Provided by customer: Zigbee gateway
 - Not suitable for use in a steam room.
- includes light bulbs with a Class G energy efficiency**

includes light bulbs with a Class G energy efficiency

	Dark Chrome	41 781 979-19
	Chrome	41 781 979-00
	Brushed Bronze	41 781 979-42
	Brushed Champagne (22kt Gold)	41 781 979-46
	Champagne (22kt Gold)	41 781 979-47
	Brushed Stainless Steel	41 781 979-86
	Brushed Dark Platinum	41 781 979-99

Required miscellaneous



SERENITY SKY+ Concealed ceiling installation box with light - 35 781 970 90

- concealed rough parts
- 2x female thread 1/2" connections
- flush-mounted reflection box, 662 x 482 mm, RAL 9003, Signal White
- min. recess depth 150 mm
- weight 15kg
- Supply pipe 7 m
- Input 100-240V AC 50-60Hz
- Output 24V DC SELV / Class 2
- ZigBee Light Link RGBW controller
- Provided by customer: Zigbee gateway



SERENITY SKY+ Rain panel for recessed ceiling installation with light - Dark Chrome

41 781 979
mm [inches]
1:10'

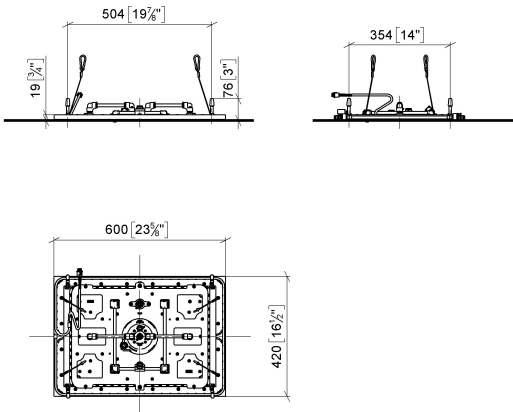

Flow rate chart

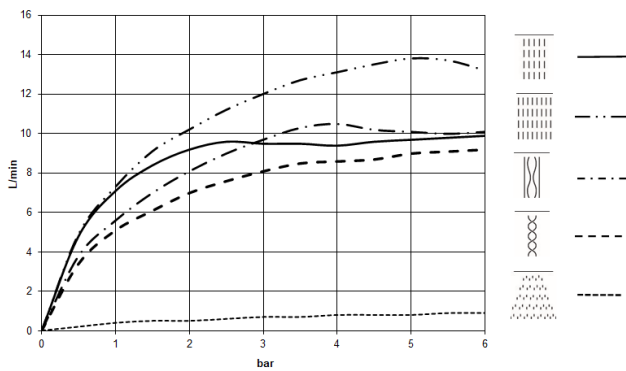



SERENITY SKY+ Rain panel for recessed ceiling installation with light - Dark Chrome

41 781 979



SERENITY SKY+ Rain panel for recessed ceiling installation with light - Dark Chrome

41 781 979

Spare parts list