







CL.1 Tissue holder without cover - Brushed Dark Platinum

CL.1

83 500 705

- width 200mm
- height 35 mm
- 70mm projection



| | | |
|---|-------------------------------|---------------|
|  | Brushed Dark Platinum | 83 500 705-99 |
|  | Chrome | 83 500 705-00 |
|  | Brushed Platinum | 83 500 705-06 |
|  | Dark Chrome | 83 500 705-19 |
|  | Brushed Champagne (22kt Gold) | 83 500 705-46 |
|  | Champagne (22kt Gold) | 83 500 705-47 |

83 500 705

mm [inches]

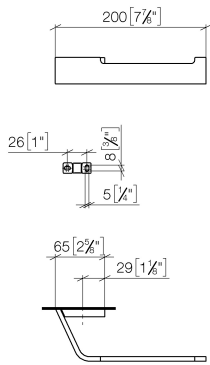

83 500 705

Parts for other finishes can be found here: [Chrome](#)

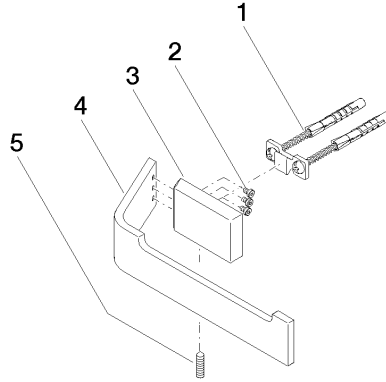

Spare parts list

| No. | Item Number | Name | Quantity used | Delivery time |
|-----|--------------------|------------|---------------|---------------|
| 1 | 05 17 20 758 00 90 | fixing set | 1 | 2 |
| 2 | 09 30 30 191 90 | screw | 3 | 2 |
| 3 | 08 17 70 500-99 | holder | 1 | 30 |
| 4 | 08 17 70 553-99 | holder | 1 | 30 |
| 5 | 04 31 11 113 00 90 | pin | 1 | 2 |