







ST 010 206 2811



- 160mm projection
- fixed spout
- rectangular, air-enriched flow
- hole diameter valve 37 mm
- hole diameter spout 37 mm
- handle Ø 60mm
- max. flow 4.5 l/min
- lead-free
- with hot / cold marking
- This product can help a building meet the requirements of Green Building Rating Systems, e.g. LEED®, BREEAM®, DGNB

	Brushed Platinum	ST 010 206 2811-06
	Chrome	ST 010 206 2811-00
	Dark Chrome	ST 010 206 2811-19
	Brushed Durabronze (23kt Gold)	ST 010 206 2811-28
	Platinum / Brushed Platinum	ST 010 206 2811-36
	Durabronze / Brushed Durabronze (23kt Gold)	ST 010 206 2811-38
	Brushed Dark Platinum	ST 010 206 2811-99

Individual components of this set

You need the following components for this set

1x 36 707 811-06



1x 11 283 811-06





CYO Wall-mounted basin mixer without pop-up waste - Brushed Platinum

CYO







ST 010 206 2811

ST 010 206 2811



- 160mm projection
 - fixed spout
 - rectangular, air-enriched flow
 - hole diameter valve 37 mm
 - hole diameter spout 37 mm
 - handle Ø 60mm
 - max. flow 4.5 l/min
 - lead-free
 - This product can help a building meet the requirements of Green Building Rating Systems, e.g. LEED®, BREEAM®, DGNB
- NOTE: The handle inserts must be ordered separately from the fittings!**

NOTE: The handle inserts must be ordered separately from the fittings!

	Brushed Platinum	36 707 811-06
	Chrome	36 707 811-00
	Dark Chrome	36 707 811-19
	Brushed Durabrand (23kt Gold)	36 707 811-28
	Platinum / Brushed Platinum	36 707 811-36
	Durabrand / Brushed Durabrand (23kt Gold)	36 707 811-38
	Brushed Dark Platinum	36 707 811-99

Required miscellaneous



- Concealed wall-mounted mixer centred spout -** 35 700 970 90
- max. recess depth 145 mm
 - min. recess depth 85 mm

Required miscellaneous



- Concealed wall-mounted mixer variable positioning -** 35 720 970 90
- min. recess depth 85 mm
 - max. recess depth 145 mm

ST 010 206 2811

mm [inches]

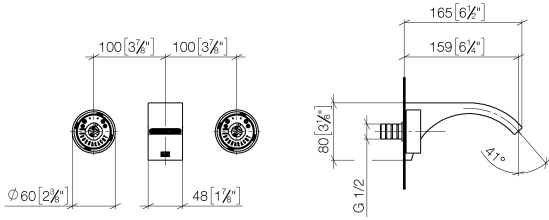

Flow rate chart

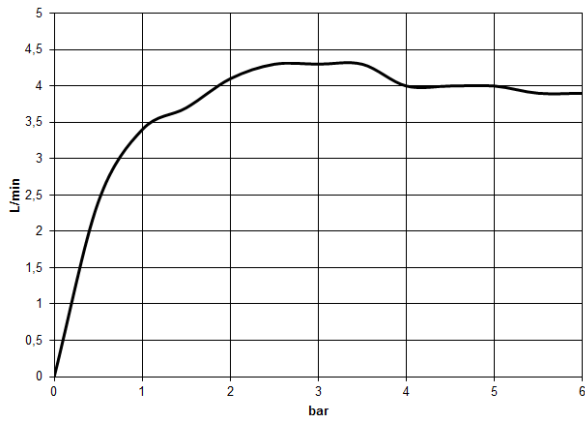

Certificates

WRAS_2111006. IAPMO_N-4976 (2). IAPMO_8834 (2). IAPMO_6397 (2). IAPMO_4976 (1).

LGA_38121.

ST 010 206 2811

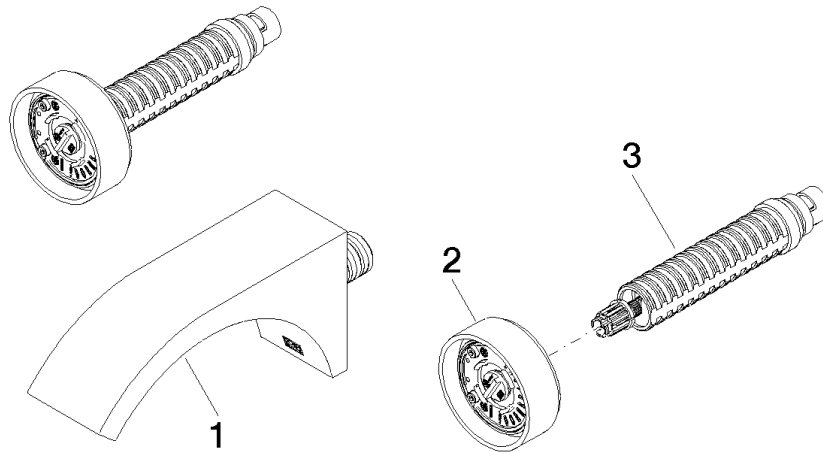

Spare parts list

No.	Item Number	Name	Quantity used	Delivery time
1	13 800 811-06	CYO Wall-mounted basin spout without pop-up waste - Brushed Platinum	1	10
2	90 18 40 290 00-06	handle	1	10
3	90 90 03 171 01 90	top	1	2

ST 010 206 2811

- with hot / cold marking
- for three-hole basin mixers and five-hole bath mixers



	Brushed Platinum	11 283 811-06
	Chrome	11 283 811-00
	Platinum	11 283 811-08
	Durabress (23kt Gold)	11 283 811-09
	Dark Chrome	11 283 811-19
	Brushed Durabress (23kt Gold)	11 283 811-28
	Brushed Champagne (22kt Gold)	11 283 811-46
	Champagne (22kt Gold)	11 283 811-47
	Brushed Dark Platinum	11 283 811-99



CYO Wall-mounted basin mixer without pop-up waste - Brushed Platinum

CYO

ST 010 206 2811



CYO Wall-mounted basin mixer without pop-up waste - Brushed Platinum

CYO

ST 010 206 2811

ST 010 206 2811

Parts for other finishes can be found here: [Chrome](#)

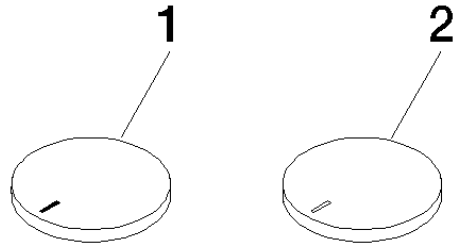

Spare parts list

No.	Item Number	Name	Quantity used	Delivery time
1	11 183 811-06	CYO Handle insert hot - Brushed Platinum	1	10
2	11 184 811-06	CYO Handle insert cold - Brushed Platinum	1	10