

**WATER FALL Schwallauslauf für Wandmontage - Champagne gebürstet (22kt Gold)**













IMO

13 420 979



- Ausladung 120 mm
- CASCADE, Durchfluss max. 26,5 l/min (bei 3 Bar)
- Abdeckplatte 240 x 60 mm
- Anschluss 1/2"
- Steckanschluss-Montage

Passt zu: IMO, LULU, MADISON, MEM, TARA, CL.1, LISSÉ, VAIA, META, CYO

	Champagne gebürstet (22kt Gold)	13 420 979-46
	Chrom	13 420 979-00
	Platin gebürstet	13 420 979-06
	Platin	13 420 979-08
	Dark Chrome	13 420 979-19
	Light Gold	13 420 979-26
	Light Gold gebürstet	13 420 979-27
	Messing gebürstet (23kt Gold)	13 420 979-28
	Schwarz matt	13 420 979-33
	Bronze gebürstet	13 420 979-42
	Champagne (22kt Gold)	13 420 979-47
	Chrom gebürstet	13 420 979-93

**Empfohlenes Zubehör**



**UP-Wandwinkel -**

- Max. Einbautiefe 163 mm
- Min. Einbautiefe 90 mm

35 085 970 90

**Empfohlenes Zubehör**



**UP-Wandwinkel -**

- Max. Einbautiefe 163 mm
- Min. Einbautiefe 90 mm

35 085 970 90

13 420 979  
mm [inches]

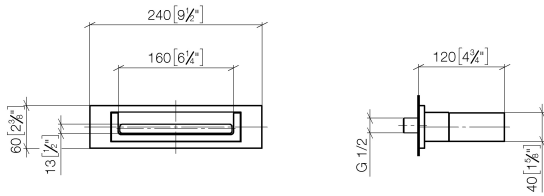

**Durchflussdiagramm**

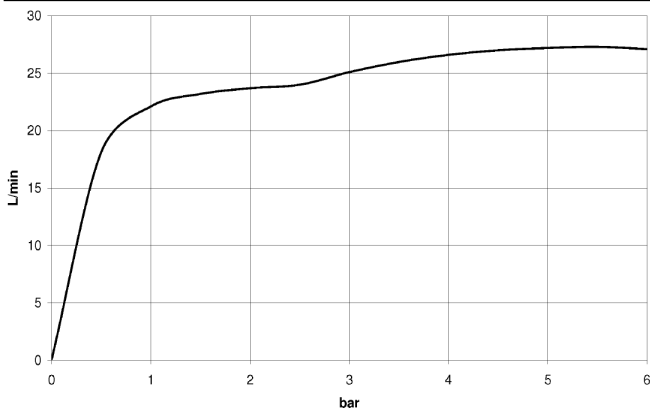

**Wurfweitendiagramm**

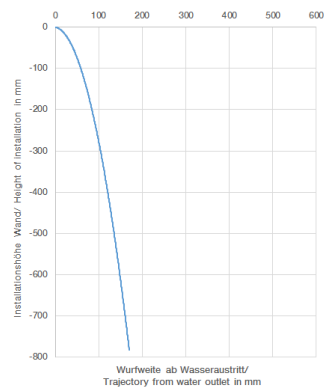

**Zertifikate**

LGA\_18615.

13 420 979

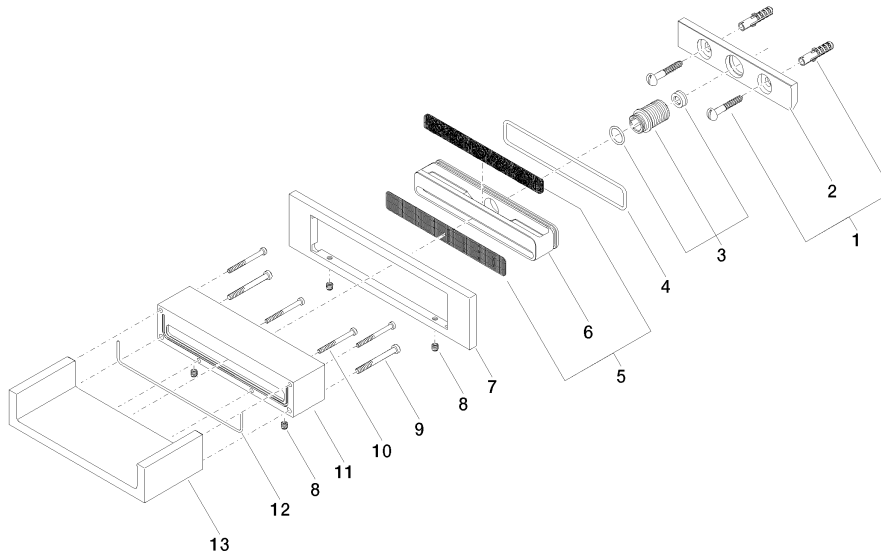

**Ersatzteilstückliste**

Nr.	Artikelnummer	Benennung	Verbaumenge	Lieferzeit
1	04 30 31 024 01 90	Befestigungssatz	1	2
2	09 17 97 056 90	Halter	1	2
3	90 24 05 008 00 90	Nippel Set	1	2
4	09 14 10 504 90	Dichtung	1	2
5	90 29 30 040 00 90	Einsatz	1	2
6	09 17 11 044 20 90	Verteiler	1	2
7	09 27 97 034-46	Rosette	1	30
8	09 31 11 049 90	Stift	4	2
9	09 30 30 147 90	Schraube	2	2
10	09 30 30 086 90	Schraube	4	2
11	09 30 01 104-46	Gehäuse	1	30
12	09 14 03 504 90	Dichtung	1	2
13	09 11 94 046-46	Auslauf	1	30