





22 585 809



- Ausladung 202 mm
- schwenkbarer Auslauf 360°
- runder luftangereicherter Strahl
- Höhe gesamt 1251 - 1321 mm
- Höhe bis Luftsprudler 1152 - 1222 mm
- Rosette Ø 135 mm
- Durchfluss max. 5,7 l/min
- bleifrei
- Dieses Produkt leistet einen Beitrag zur Erfüllung der Vorgaben von nachhaltigen Gebäudezertifizierungen, z.B. LEED®, BREEAM®, DGNB

	Dark Chrome	22 585 809-19
	Chrom	22 585 809-00
	Platin gebürstet	22 585 809-06
	Platin	22 585 809-08
	Messing gebürstet (23kt Gold)	22 585 809-28
	Bronze gebürstet	22 585 809-42
	Champagne gebürstet (22kt Gold)	22 585 809-46
	Champagne (22kt Gold)	22 585 809-47
	Dark Platinum gebürstet	22 585 809-99

**Benötigtes Zubehör**



**UP-Bodenbefestigung -**

- Max. Einbautiefe 150 mm
- Min. Einbautiefe 80 mm

35 945 970 90

22 585 809  
mm [inches]

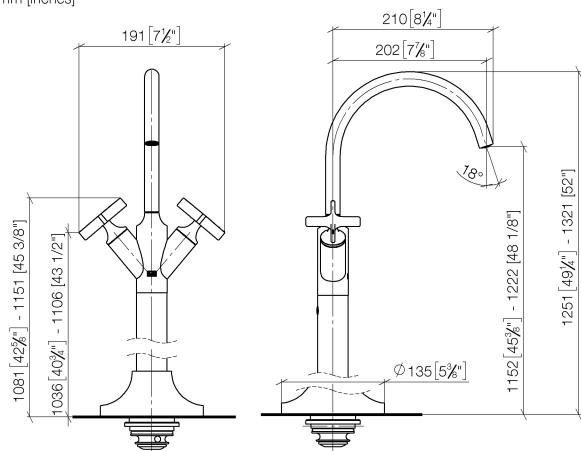

**Durchflussdiagramm**



**Zertifikate**

LGA\_38416.

WRAS\_240102001.

22 585 809

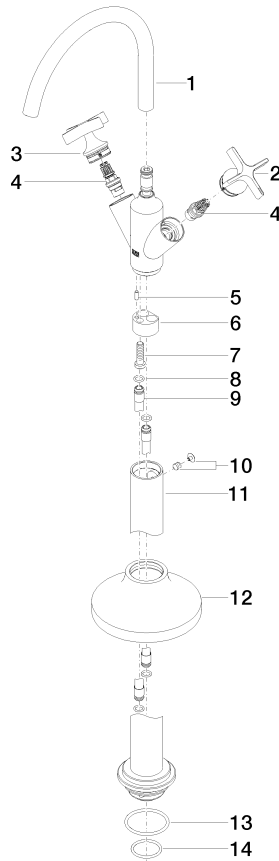

**Ersatzteilstückliste**

Nr.	Artikelnummer	Benennung	Verbaumenge	Lieferzeit
1	90 28 22 313 00-19	Auslauf	1	20
2	90 20 66 028 00-19	Griff ( cold )	1	20
3	90 20 66 029 01-19	Griff ( hot )	1	20
4	90 90 03 175 00 90	Oberteil	2	2
5	09 31 11 040 90	Stift	1	2
6	09 24 03 193 90	Adapter	1	2
7	09 30 30 047 90	Schraube	1	2
8	09 14 10 139 90	Dichtung	4	2
9	04 28 22 022 10 90	Anschluss	2	2
10	04 31 11 002 00 90	Stift	1	2
11	04 28 22 028 00-19	Rohr	1	60
12	90 27 80 033 00-19	Rosette	1	20
13	09 14 10 084 90	Dichtung	1	2
14	09 14 10 018 90	Dichtung	1	2