







27 838 979



Passt zu: IMO, MEM, CL.1, CYO

- LAMINAR FLOW, Durchfluss max. 15 l/min (bei 3 Bar)
- Brauseabgang 3/8"
- Abdeckplatte 240 x 60 mm
- Metallbrauseschlauch 1250 mm mit integriertem Verdrehschutz
- Anschluss 1/2"
- Steckanschluss-Montage

Eigensicher gegen Rückfließen.

	Chrom gebürstet	27 838 979-93
	Chrom	27 838 979-00
	Platin gebürstet	27 838 979-06
	Platin	27 838 979-08
	Dark Chrome	27 838 979-19
	Light Gold gebürstet	27 838 979-27
	Messing gebürstet (23kt Gold)	27 838 979-28
	Schwarz matt	27 838 979-33
	Dark Platinum gebürstet	27 838 979-99

Empfohlenes Zubehör

UP-Wandwinkel - 35 085 970 90



- Max. Einbautiefe 163 mm
- Min. Einbautiefe 90 mm

27 838 979

mm [inches]



Durchflussdiagramm



Codes & Standards

DIN 4109

EN 1717

ISO 3822

Ü-Zeichen



Gießrohr mit Abdeckplatte - Chrom gebürstet

IMO

27 838 979

Zertifikate

Belgaqua_21-023-2 LGA_38

27 838 979

Produktversion bis 3/2/2021

Produktversion ab 3/2/2021

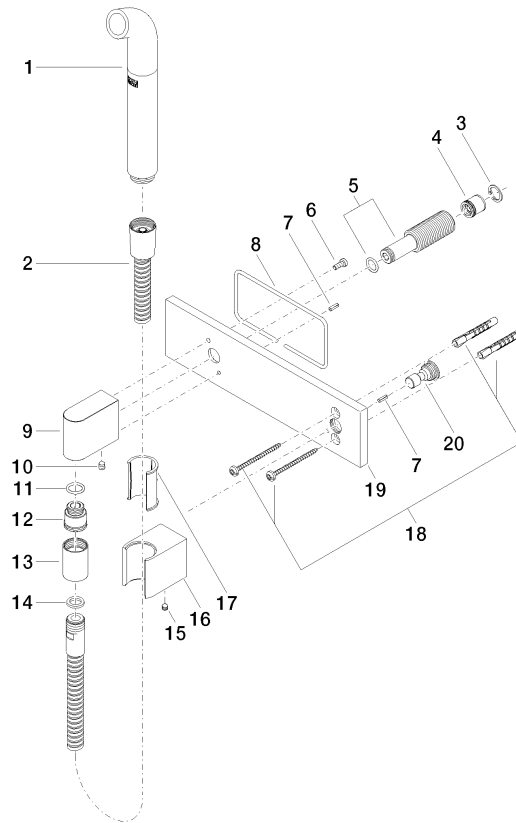



Gießrohr mit Abdeckplatte - Chrom gebürstet

IMO

27 838 979

Ersatzteilstückliste

Produktversion bis 3/2/2021

Produktversion ab 3/2/2021

Nr.	Artikelnummer	Benennung	Verbaumenge	Lieferzeit
	04 12 11 073 01-93	Auslauf	21	20