















28 002 978



- Dreifach verstellbar: COMPACT RAIN, COMPACT SOFT FLOW, COMPACT AQUAPRESSURE FLOW, Durchfluss max. 6,8 l/min (bei 3 Bar)
- mit Antikalk-System
- Brausekopf Ø 95 mm
- Anschluss 1/2"
- Dieses Produkt leistet einen Beitrag zur Erfüllung der Vorgaben von nachhaltigen Gebäudezertifizierungen, z.B. LEED®, BREEAM®, DGNB

Eigensicher gegen Rückfließen.

	Dark Platinum gebürstet	28 002 978-99 0010
	Chrom	28 002 978-00
	Chrom	28 002 978-00 0010
	Platin gebürstet	28 002 978-06
	Platin gebürstet	28 002 978-06 0010
	Platin	28 002 978-08
	Platin	28 002 978-08 0010
	Messing (23kt Gold)	28 002 978-09
	Messing (23kt Gold)	28 002 978-09 0010
	Messing gebürstet (23kt Gold)	28 002 978-28
	Messing gebürstet (23kt Gold)	28 002 978-28 0010
	Chrom gebürstet	28 002 978-93
	Chrom gebürstet	28 002 978-93 0010
	Dark Platinum gebürstet	28 002 978-99

28 002 978

mm [inches]

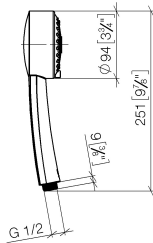

Durchflussdiagramm

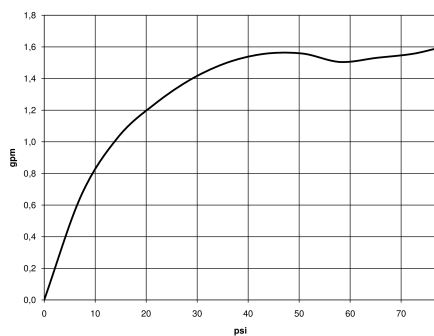

Zertifikate

LGA_18610.

IAPMO_11777.

IAPMO_4976 (1).

28 002 978

Ersatzteile für die
anderen
Oberflächenvarianten
finden Sie hier:
Chrom

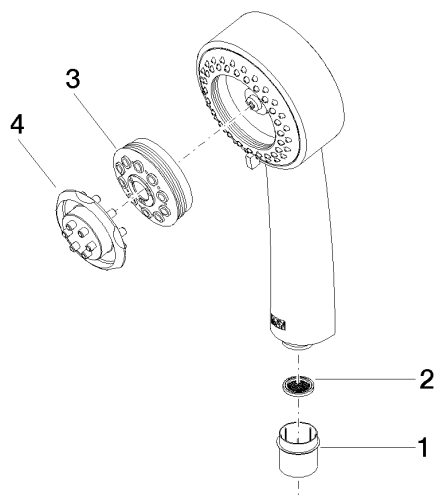

Ersatzteilstückliste

Nr.	Artikelnummer	Benennung	Verbaumenge	Lieferzeit
1	09 21 02 115 90	Kappe	1	2
2	09 23 01 039 90	Sieb	1	2
3	04 12 11 071 00 90	Brause	1	2
4	09 30 09 022 90	Schlüssel	1	2