

























28 017 979



- COMPACT RAIN, Durchfluss max. 15 l/min (bei 3 Bar)
- mit Antikalk-System
- Brausekopf Ø 130 mm
- Anschluss 1/2"

Eigensicher gegen Rückfließen.

Passt zu: IMO, LULU, MADISON, MEM, TARA, CL.1, LISSÉ, VAIA, META, CYO

	Light Gold gebürstet	28 017 979-27
	Chrom	28 017 979-00 0010
	Chrom	28 017 979-00
	Platin gebürstet	28 017 979-06 0010
	Platin gebürstet	28 017 979-06
	Platin	28 017 979-08
	Platin	28 017 979-08 0010
	Dark Chrome	28 017 979-19
	Dark Chrome	28 017 979-19 0010
	Light Gold	28 017 979-26 0010
	Light Gold	28 017 979-26
	Light Gold gebürstet	28 017 979-27 0010
	Messing gebürstet (23kt Gold)	28 017 979-28
	Messing gebürstet (23kt Gold)	28 017 979-28 0010
	Schwarz matt	28 017 979-33
	Schwarz matt	28 017 979-33 0010
	Bronze gebürstet	28 017 979-42
	Bronze gebürstet	28 017 979-42 0010
	Champagne gebürstet (22kt Gold)	28 017 979-46 0010
	Champagne gebürstet (22kt Gold)	28 017 979-46
	Champagne (22kt Gold)	28 017 979-47
	Champagne (22kt Gold)	28 017 979-47 0010
	Chrom gebürstet	28 017 979-93
	Chrom gebürstet	28 017 979-93 0010
	Dark Platin gebürstet	28 017 979-99 0010
	Dark Platin gebürstet	28 017 979-99



Handbrause - Light Gold gebürstet

IMO

28 017 979

28 017 979

mm [inches]

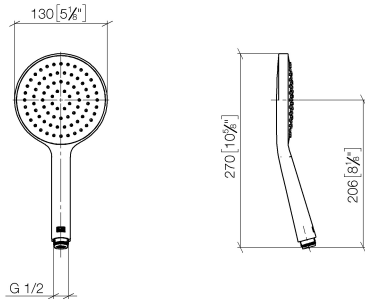

Durchflussdiagramm



Codes & Standards

DIN 4109

ISO 3822

Ü-Zeichen



Handbrause - Light Gold gebürstet

IMO

28 017 979

Zertifikate

LGA_29

28 017 979

Produktversion ab 4/1/2024

Ersatzteile für die
anderen
Oberflächenvarianten
finden Sie hier:
Chrom

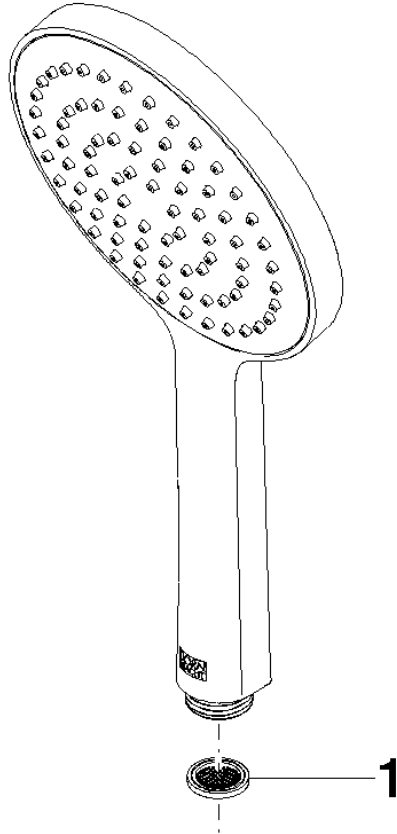



Handbrause - Light Gold gebürstet

IMO

28 017 979

Ersatzteilstückliste

Produktversion ab 4/1/2024

Nr.	Artikelnummer	Benennung	Verbaumenge	Lieferzeit
	09 23 01 039 90	Sieb	1	2