







28 450 410



- Brauseabgang 1/2"
- Rosette Ø 55 mm
- Anschluss 1/2"

Eigensicher gegen Rückfließen.

	Messing gebürstet (23kt Gold)	28 450 410-28
	Chrom	28 450 410-00
	Platin gebürstet	28 450 410-06
	Platin	28 450 410-08
	Messing (23kt Gold)	28 450 410-09
	Dark Platinum gebürstet	28 450 410-99

Empfohlenes Zubehör

UP-Wandwinkel - 35 085 970 90



- Max. Einbautiefe 163 mm
- Min. Einbautiefe 90 mm

28 450 410

mm [inches]

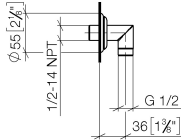

Durchflussdiagramm



Zertifikate

Belgaqua_21-381- WRAS_240502026.
27_7.

28 450 410

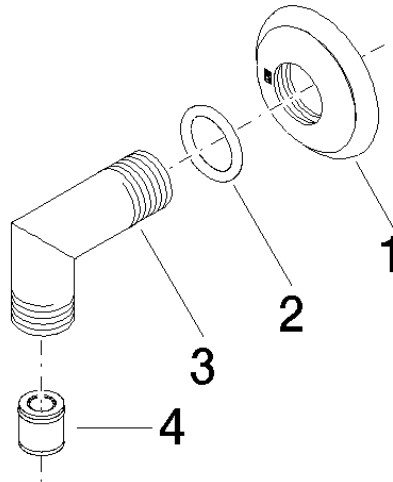

Ersatzteilstückliste

Nr.	Artikelnummer	Benennung	Verbaumenge	Lieferzeit
1	09 27 35 003-28	Rosette	1	60
2	90 14 10 026 00 90	Dichtung	1	2
3	09 11 03 121-28	Anschluss	1	60
4	90 23 01 141 00 90	Rueckflussverhinderer	1	2