













28 508 360



- Ausladung 200 mm
- Kugelgelenk 30° schwenkbar
- Dreifach verstellbar: PURIFY RAIN, COMPACT SOFT FLOW, COMPACT AQUAPRESSURE FLOW, Durchfluss max. 7,6 l/min (bei 3 Bar)
- mit Antikalk-System
- Brausekopf Ø 94 mm
- Rosette Ø 55 mm
- Anschluss 1/2"
- Dieses Produkt leistet einen Beitrag zur Erfüllung der Vorgaben von nachhaltigen Gebäudezertifizierungen, z.B. LEED®, BREEAM®, DGNB

	Dark Platinum gebürstet	28 508 360-99 0010
	Chrom	28 508 360-00 0010
	Chrom	28 508 360-00
	Platin gebürstet	28 508 360-06 0010
	Platin gebürstet	28 508 360-06
	Platin	28 508 360-08 0010
	Platin	28 508 360-08
	Messing (23kt Gold)	28 508 360-09 0010
	Messing (23kt Gold)	28 508 360-09
	Messing gebürstet (23kt Gold)	28 508 360-28 0010
	Messing gebürstet (23kt Gold)	28 508 360-28
	Dark Platinum gebürstet	28 508 360-99

28 508 360

mm [inches]

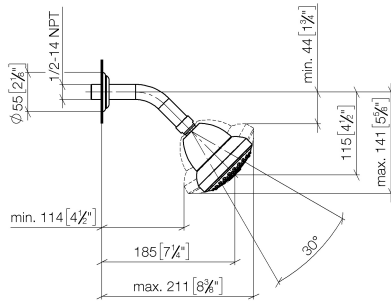

Durchflussdiagramm

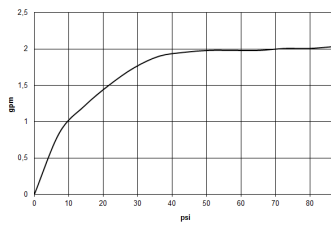

Zertifikate

LGA_38653.

28 508 360

Ersatzteile für die
anderen
Oberflächenvarianten
finden Sie hier:
Chrom

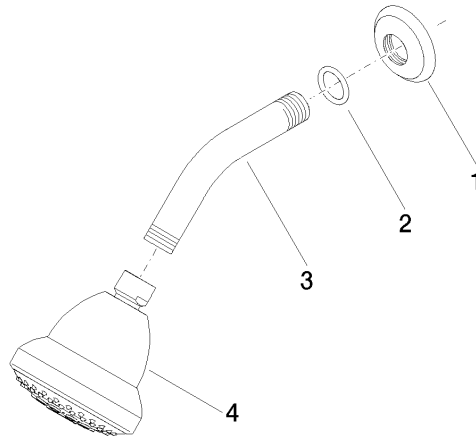

Ersatzteilstückliste

Nr.	Artikelnummer	Benennung	Verbaumenge	Lieferzeit
1	09 27 35 003-99	Rosette	1	30
2	90 14 10 026 00 90	Dichtung	1	2
3	09 11 03 011-99	Anschluss	1	30
4	04 12 11 120 01-99	Brause	1	30