























28 508 980



Passt zu: IMO, MEM, CL.1, CYO

- Ausladung 200 mm
- Kugelgelenk 30° schwenkbar
- Dreifach verstellbar: PURIFY RAIN, COMPACT SOFT FLOW, COMPACT AQUAPRESSURE FLOW, Durchfluss max. 6,8 l/min (bei 3 Bar)
- mit Antikalk-System
- Brausekopf Ø 92 mm
- Rosette 60 x 60 mm
- Anschluss 1/2"
- Dieses Produkt leistet einen Beitrag zur Erfüllung der Vorgaben von nachhaltigen Gebäudezertifizierungen, z.B. LEED®, BREEAM®, DGNB

	Schwarz matt	28 508 980-33 0010
	Chrom	28 508 980-00 0010
	Chrom	28 508 980-00
	Platin gebürstet	28 508 980-06 0010
	Platin gebürstet	28 508 980-06
	Platin	28 508 980-08 0010
	Platin	28 508 980-08
	Dark Chrome	28 508 980-19 0010
	Dark Chrome	28 508 980-19
	Light Gold gebürstet	28 508 980-27 0010
	Light Gold gebürstet	28 508 980-27
	Messing gebürstet (23kt Gold)	28 508 980-28 0010
	Messing gebürstet (23kt Gold)	28 508 980-28
	Schwarz matt	28 508 980-33
	Champagne gebürstet (22kt Gold)	28 508 980-46 0010
	Champagne gebürstet (22kt Gold)	28 508 980-46
	Champagne (22kt Gold)	28 508 980-47 0010
	Champagne (22kt Gold)	28 508 980-47
	Chrom gebürstet	28 508 980-93 0010
	Chrom gebürstet	28 508 980-93
	Dark Platin gebürstet	28 508 980-99 0010
	Dark Platin gebürstet	28 508 980-99

28 508 980

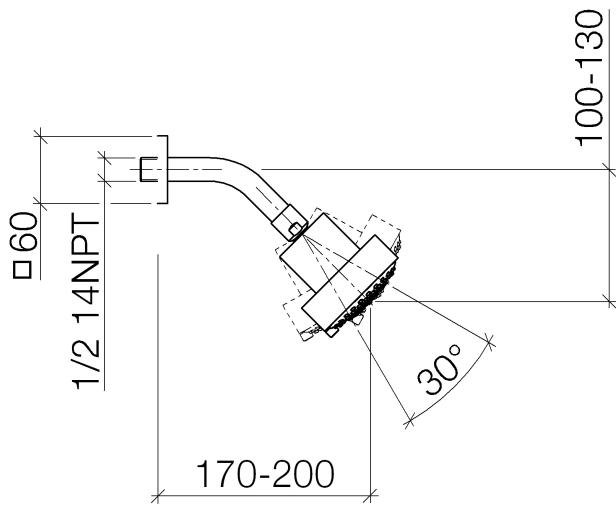

Durchflussdiagramm



Zertifikate

IAPMO_4976 (6). LGA_38653.

28 508 980

Ersatzteile für die
anderen
Oberflächenvarianten
finden Sie hier:
Chrom

