













28 659 970



- Ausladung 450 mm
- Regenbrause Ø 400 mm
- PURE RAIN, Durchfluss max. 20 l/min (bei 3 Bar)
- Funktion ab: 12 l/min
- Rosette Ø 60 mm
- Anschluss 1/2"
- mit Antikalk-System

Produktänderung zum 1.4.2024: Durchfluss max. 20l/min

Passt zu: TARA, LISSÉ, VAIA, META

	Chrom gebürstet	28 659 970-93
	Chrom	28 659 970-00
	Platin gebürstet	28 659 970-06
	Platin	28 659 970-08
	Dark Chrome	28 659 970-19
	Light Gold	28 659 970-26
	Light Gold gebürstet	28 659 970-27
	Messing gebürstet (23kt Gold)	28 659 970-28
	Schwarz matt	28 659 970-33
	Bronze gebürstet	28 659 970-42
	Champagne gebürstet (22kt Gold)	28 659 970-46
	Champagne (22kt Gold)	28 659 970-47
	Dark Platin gebürstet	28 659 970-99

Empfohlenes Zubehör

UP-Wandwinkel - 35 085 970 90



- Max. Einbautiefe 163 mm
- Min. Einbautiefe 90 mm

28 659 970



Durchflussdiagramm

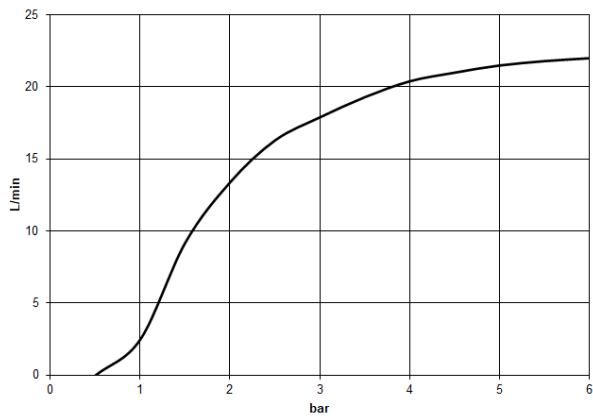

Zertifikate

LGA_29237.

LGA_29238.

WRAS_2212012.

DVGW_DW-6517DN0118.

28 659 970

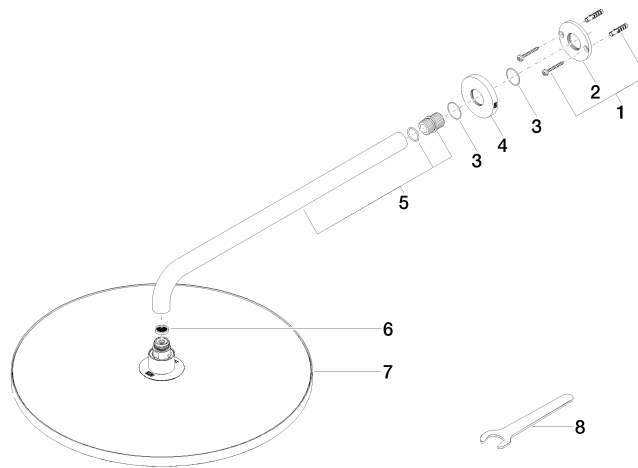

Ersatzteilstückliste

Nr.	Artikelnummer	Benennung	Verbaumenge	Lieferzeit
1	04 30 31 032 00 90	Befestigungssatz	1	2
2	09 17 20 120 90	Halter	1	2
3	09 14 10 150 90	Dichtung	2	2
4	09 27 97 015-93	Rosette	1	20
5	90 11 03 070 00-93	Rohr	1	20
6	09 23 01 075 90	Einsatz	1	2
7	04 12 05 090 00-93	Brause	1	20
8	90 30 09 069 00 90	Schlüssel	1	2