











30 010 662



- Ausladung 126 mm
- starrer Auslauf
- runder luftangereicherter Strahl
- Bohrungsdurchmesser 35 mm
- Rosette Ø 60 mm
- Durchfluss max. 5,7 l/min
- bleifrei
- Dieses Produkt leistet einen Beitrag zur Erfüllung der Vorgaben von nachhaltigen Gebäudezertifizierungen, z.B. LEED®, BREEAM®, DGNB

	Dark Platinum gebürstet	30 010 662-99
	Chrom	30 010 662-00
	Platin gebürstet	30 010 662-06
	Dark Chrome	30 010 662-19
	Light Gold	30 010 662-26
	Light Gold gebürstet	30 010 662-27
	Schwarz matt	30 010 662-33
	Bronze gebürstet	30 010 662-42
	Champagne gebürstet (22kt Gold)	30 010 662-46
	Champagne (22kt Gold)	30 010 662-47
	Chrom gebürstet	30 010 662-93

Empfohlenes Zubehör

- UP-Wandwinkel -** 35 085 970 90
- Min. Einbautiefe 90 mm
 - Max. Einbautiefe 163 mm



30 010 662

mm [inches]

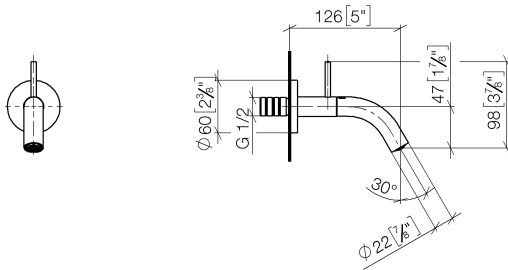

Durchflussdiagramm

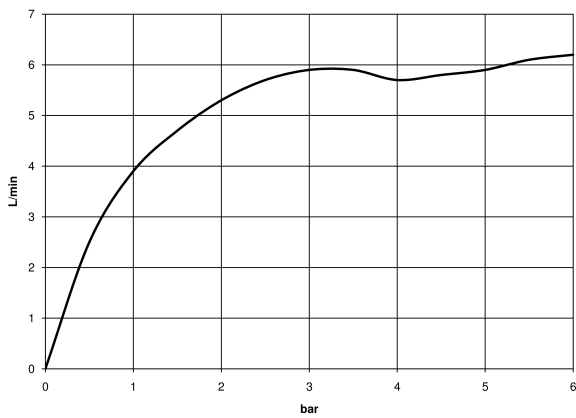

Zertifikate

LGA_38414.

30 010 662

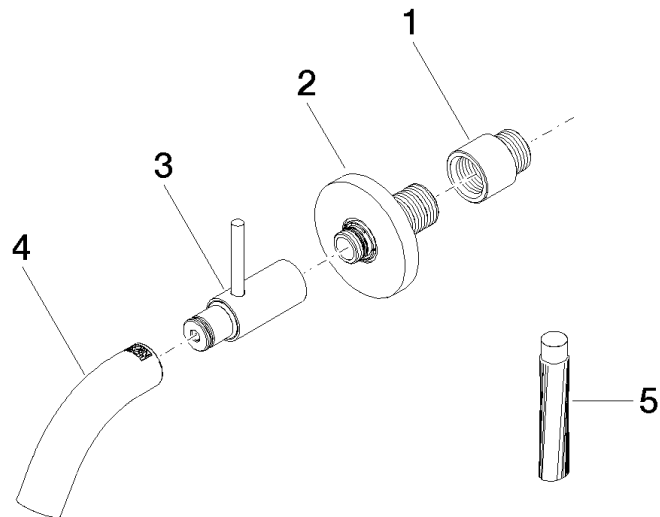

Ersatzteilstückliste

Nr.	Artikelnummer	Benennung	Verbaumenge	Lieferzeit
1	09 24 03 072 10 90	Nippel	1	2
2	90 27 66 019 00-99	Rosette	1	30
3	90 20 66 023 00-99	Griff	1	30
4	90 28 22 385 00-99	Auslauf	1	30
5	09 16 03 001 90	Fett	1	2