











33 800 682



- Ausladung 201 mm
- schwenkbarer Auslauf 360°
- optional schwenkbegrenzbar mit Schwenkbegrenzungsset 12 820 970 90
- luftangereicherter Strahl
- Durchfluss max. 6,3 l/min bei 3 bar Fließdruck
- bleifrei
- Dieses Produkt leistet einen Beitrag zur Erfüllung der Vorgaben von nachhaltigen Gebäudezertifizierungen, z.B. LEED®, BREEAM®, DGNB

	Messing gebürstet (23kt Gold)	33 800 682-28
	Chrom	33 800 682-00
	Platin gebürstet	33 800 682-06
	Platin	33 800 682-08
	Messing (23kt Gold)	33 800 682-09
	Dark Chrome	33 800 682-19
	Schwarz matt	33 800 682-33
	Champagne gebürstet (22kt Gold)	33 800 682-46
	Champagne (22kt Gold)	33 800 682-47
	Chrom gebürstet (Edelstahl-Look)	33 800 682-93
	Dark Platin gebürstet	33 800 682-99

Empfohlenes Zubehör



Schwenkbegrenzungsset - 12 820 970 90

Empfohlenes Zubehör



Exzenterbetätigung mit Drehknopf - Messing gebürstet (23kt Gold) 10 712 970-28

Empfohlenes Zubehör



Spender ohne Rosette - Messing gebürstet (23kt Gold) 82 424 970-28

33 800 682

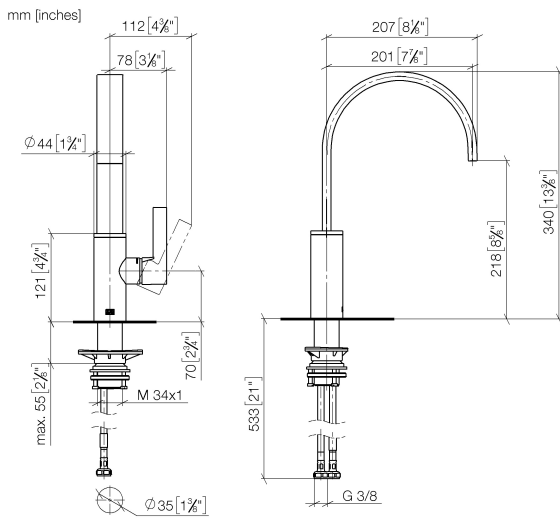

Durchflussdiagramm

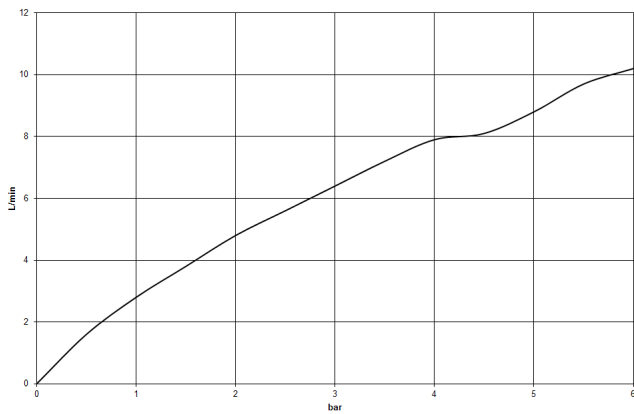

Zertifikate

LGA_38646.

WRAS_240202021.

33 800 682

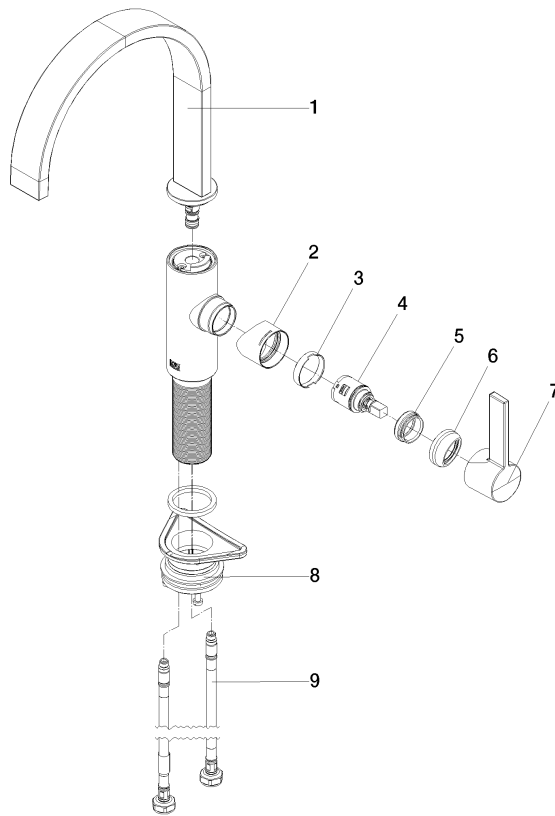

Ersatzteilstückliste

Nr.	Artikelnummer	Benennung	Verbaumenge	Lieferzeit
1	90 28 22 332 00-28	Auslauf	1	-
Ersatzteil nicht mehr bestellbar, bitte bestellen Sie den Nachfolgeartikel				
2	09 19 86 012-28	Haube	1	60
3	90 23 10 128 00 90	Mutter	1	2
4	90 15 05 042 00 90	Kartusche	1	2
5	09 24 04 266 90	Mutter	1	2
6	90 28 30 052 00-28	Haube	1	20
7	90 20 86 004 00-28	Griff	1	20
8	04 23 10 044 08 90	Befestigungssatz	1	2
9	04 30 04 101 00 90	Schlauch	2	2