











33 800 861



- Ausladung 200 mm
- schwenkbarer Auslauf 360°
- optional schwenkbegrenzbar mit Schwenkbegrenzungsset 12 820 970 90
- luftangereicherter Strahl
- Durchfluss max. 8 l/min bei 3 bar Fließdruck
- bleifrei
- Dieses Produkt leistet einen Beitrag zur Erfüllung der Vorgaben von nachhaltigen Gebäudezertifizierungen, z.B. LEED®, BREEAM®, DGNB

| | | |
|---|----------------------------------|---------------|
|  | Dark Platinum gebürstet | 33 800 861-99 |
|  | Chrom | 33 800 861-00 |
|  | Platin gebürstet | 33 800 861-06 |
|  | Platin | 33 800 861-08 |
|  | Messing (23kt Gold) | 33 800 861-09 |
|  | Dark Chrome | 33 800 861-19 |
|  | Messing gebürstet (23kt Gold) | 33 800 861-28 |
|  | Schwarz matt | 33 800 861-33 |
|  | Champagne gebürstet (22kt Gold) | 33 800 861-46 |
|  | Champagne (22kt Gold) | 33 800 861-47 |
|  | Chrom gebürstet (Edelstahl-Look) | 33 800 861-93 |

Empfohlenes Zubehör

Schwenkbegrenzungsset - 12 820 970 90



Empfohlenes Zubehör

Exzenterbetätigung mit Drehknopf - Dark Platinum gebürstet 10 712 970-99



Empfohlenes Zubehör

Spender ohne Rosette - Dark Platinum gebürstet 82 424 970-99



33 800 861

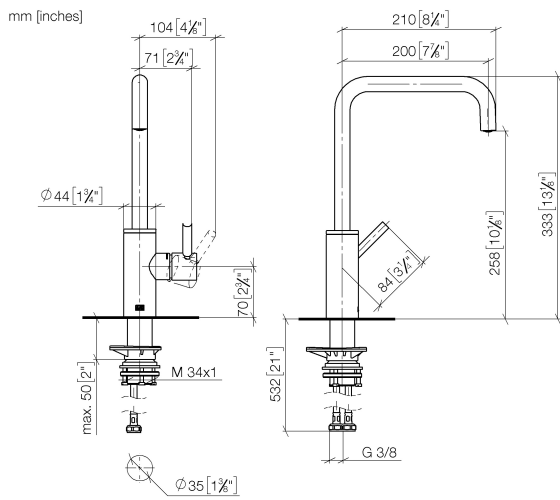

Durchflussdiagramm



Zertifikate

LGA_38642.

WRAS_240102021.

33 800 861

