











33 805 861



- Ausladung 166 mm
- schwenkbarer Auslauf 360°
- optional schwenkbegrenzbar mit Schwenkbegrenzungsset 12 820 970 90
- luftangereicherter Strahl
- Durchfluss max. 8 l/min bei 3 bar Fließdruck
- bleifrei
- Dieses Produkt leistet einen Beitrag zur Erfüllung der Vorgaben von nachhaltigen Gebäudezertifizierungen, z.B. LEED®, BREEAM®, DGNB

	Dark Chrome	33 805 861-19
	Chrom	33 805 861-00
	Platin gebürstet	33 805 861-06
	Platin	33 805 861-08
	Messing (23kt Gold)	33 805 861-09
	Messing gebürstet (23kt Gold)	33 805 861-28
	Schwarz matt	33 805 861-33
	Champagne gebürstet (22kt Gold)	33 805 861-46
	Champagne (22kt Gold)	33 805 861-47
	Chrom gebürstet (Edelstahl-Look)	33 805 861-93
	Dark Platinum gebürstet	33 805 861-99

**Empfohlenes Zubehör**

**Schwenkbegrenzungsset - 12 820 970 90**



**Empfohlenes Zubehör**

**Spender ohne Rosette - Dark Chrome 82 424 970-19**



**Empfohlenes Zubehör**

**Exzenterbetätigung mit Drehknopf - Dark Chrome 10 712 970-19**



33 805 861

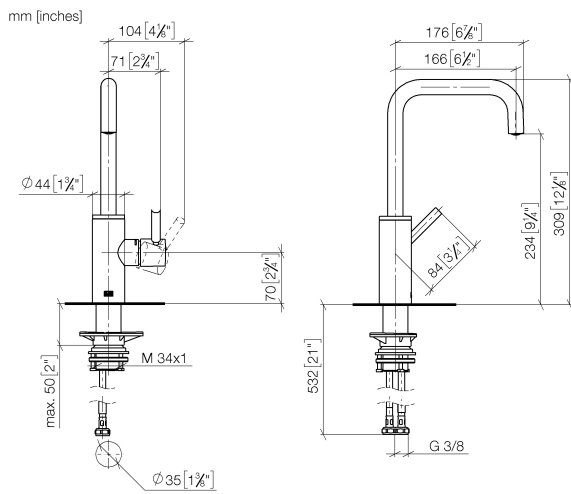

**Durchflussdiagramm**

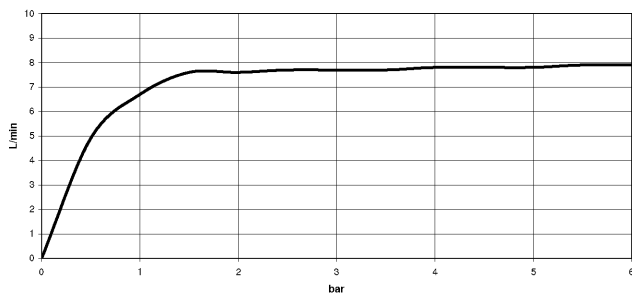

**Zertifikate**

LGA\_38642.

WRAS\_240102021.

33 805 861

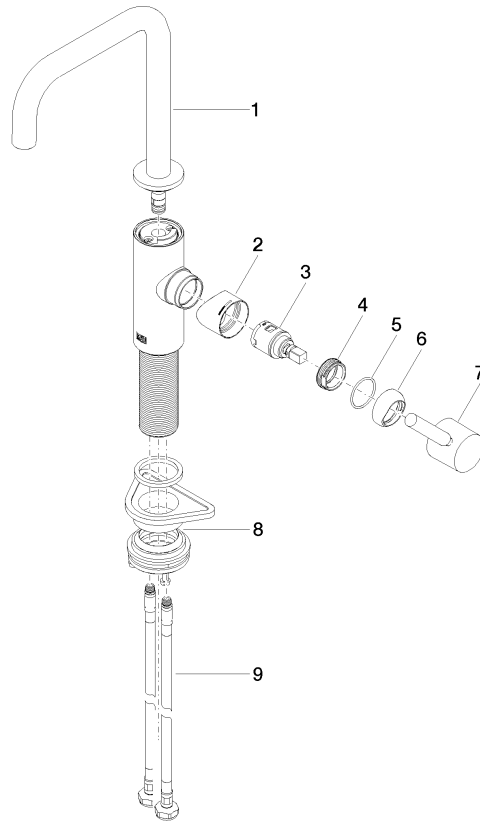

**Ersatzteilstückliste**

Nr.	Artikelnummer	Benennung	Verbaumenge	Lieferzeit
1	90 28 22 285 00-19	Auslauf	1	-
Ersatzteil nicht mehr bestellbar, bitte bestellen Sie den Nachfolgeartikel				
2	09 19 86 012-19	Haube	1	60
3	90 15 05 042 00 90	Kartusche	1	2
4	09 24 04 266 90	Mutter	1	2
5	09 14 10 091 90	Dichtung	1	2
6	90 28 30 052 00-19	Haube	1	20
7	90 20 66 003 00-19	Griff	1	20
8	04 23 10 044 08 90	Befestigungssatz	1	2
9	04 30 04 101 00 90	Schlauch	2	2