









## Brause-Thermostat für Wandmontage - Champagne gebürstet (22kt Gold)

34 443 979



- Schubrosetten Ø 70 mm
- Stichmaß 150 mm ± 13 mm
- Brauseabgang 3/8"
- mit Mengenregulierung

Eigensicher gegen Rückfließen.

	Champagne gebürstet (22kt Gold)	34 443 979-46
	Chrom	34 443 979-00
	Platin gebürstet	34 443 979-06
	Platin	34 443 979-08
	Dark Chrome	34 443 979-19
	Messing gebürstet (23kt Gold)	34 443 979-28
	Schwarz matt	34 443 979-33
	Champagne (22kt Gold)	34 443 979-47
	Chrom gebürstet	34 443 979-93
	Dark Platinum gebürstet	34 443 979-99

## Brause-Thermostat für Wandmontage - Champagne gebürstet (22kt Gold)

---

34 443 979

mm [inches]

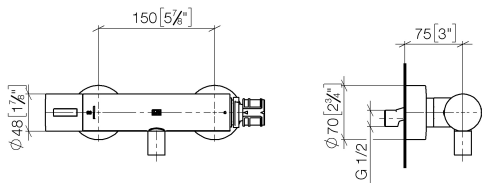

### Durchflussdiagramm

---

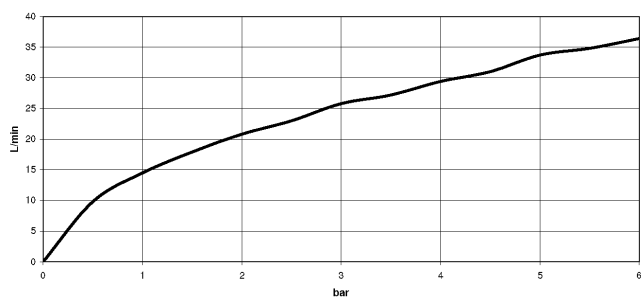

### Zertifikate

---

Belgaqua\_22\_281\_2 LGA\_29986.  
7\_5.

WRAS\_2204005.

## Brause-Thermostat für Wandmontage - Champagne gebürstet (22kt Gold)

34 443 979

Ersatzteile für die  
anderen  
Oberflächenvarianten  
finden Sie hier:  
Chrom

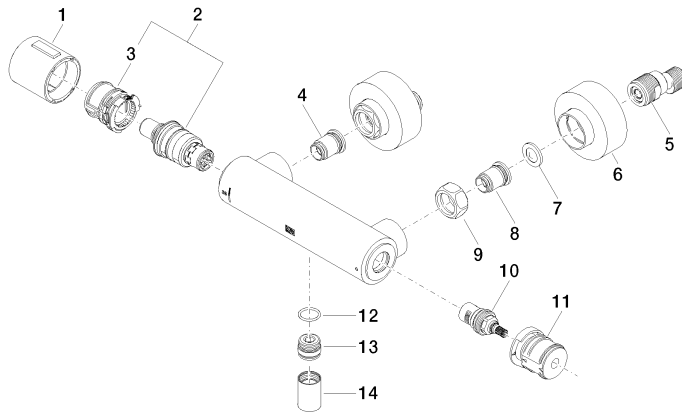

### Ersatzteilstückliste

Nr.	Artikelnummer	Benennung	Verbaumenge	Lieferzeit
1	90 17 33 015 00-46	Griff	1	30
2	90 15 02 070 00 90	Kartusche	1	2
3	90 30 40 010 00 90	Regler	1	2
4	04 31 20 530 00 90	Einsatz	1	2
5	04 11 04 030 00 90	Anschluss	2	2
6	90 31 20 512 00-46	Rosette	2	30
7	09 29 30 050 90	Sieb	2	2
8	04 31 20 540 00 90	Einsatz	1	2
9	09 24 77 008-00	Mutter	2	10
10	90 90 03 236 00 90	Oberteil	1	2
11	90 30 40 017 00 90	Aufnahme	1	2
12	90 14 10 010 00 90	Dichtung	1	2
13	09 31 20 511-46	Nippel	1	60
14	90 21 02 069 00-46	Haube	1	30