

Shower Pipe mit Brause-Thermostat ohne Handbrause - Platin gebürstet

34 459 980 Produktversion ab 6/1/2024



- Ausladung Standbrause 453 mm
- Kopfbrause: Regenstrahl
- Regenbrause 300 x 240 mm
- Regenbrause mit Antikalk-System
- Durchfluss Regenbrause max. 20 l/min (bei 3 Bar)
- Funktion ab: 12 l/min
- Drehumstellung mit Mengenregulierung und Absperrfunktion
- Schubrosetten Ø 70 mm
- Höhe Armatur bis Regenbrause (Unterkante) 1009 mm
- Höhe Armatur bis Oberkante Bogen 1150 mm
- Stichmaß 150 mm ± 13 mm
- Metallbrauseschlauch 1750 mm mit integriertem Verdrehschutz
- Anschluss 1/2"
- Wandrohr mit Schieber
- Rohrdurchmesser 23,5 mm
- mit Leerlauf-Funktion

Dieser Artikel enthält keine Handbrause!

Eigensicher gegen Rückfließen.

	Platin gebürstet	34 459 980-06
	Chrom	34 459 980-00
	Platin	34 459 980-08
	Dark Chrome	34 459 980-19
	Light Gold gebürstet	34 459 980-27
	Messing gebürstet (23kt Gold)	34 459 980-28
	Schwarz matt	34 459 980-33
	Champagne gebürstet (22kt Gold)	34 459 980-46
	Champagne (22kt Gold)	34 459 980-47
	Chrom gebürstet	34 459 980-93
	Dark Platinum gebürstet	34 459 980-99

Shower Pipe mit Brause-Thermostat ohne Handbrause - Platin gebürstet

34 459 980 Produktversion ab 6/1/2024

Benötigtes Zubehör

	Handbrause FlowReduce - Platin gebürstet	28 016 979-06 0010
---	---	-----------------------

Benötigtes Zubehör

	Handbrause FlowReduce - Platin gebürstet	28 012 979-06 0010
---	---	-----------------------

Benötigtes Zubehör

	Handbrause - Platin gebürstet	28 012 979-06
---	--------------------------------------	---------------

Benötigtes Zubehör

	Handbrause FlowReduce - Platin gebürstet	28 018 979-06 0010
---	---	-----------------------

Benötigtes Zubehör

	SERIENNEUTRAL Handbrause FlowReduce - Platin gebürstet	28 025 979-06 0010
---	---	-----------------------

Benötigtes Zubehör

	SERIENNEUTRAL Handbrause FlowReduce - Platin gebürstet	28 029 979-06 0010
---	---	-----------------------

Benötigtes Zubehör

	Handbrause - Platin gebürstet	28 017 979-06
---	--------------------------------------	---------------

Benötigtes Zubehör

	Handbrause - Platin gebürstet	28 016 979-06
---	--------------------------------------	---------------

Benötigtes Zubehör

	Handbrause - Platin gebürstet	28 018 979-06
---	--------------------------------------	---------------

Benötigtes Zubehör

	SERIENNEUTRAL Handbrause - Platin gebürstet	28 029 979-06
---	--	---------------

Benötigtes Zubehör

	SERIENNEUTRAL Handbrause FlowReduce - Platin gebürstet	28 027 979-06 0010
---	---	-----------------------

Shower Pipe mit Brause-Thermostat ohne Handbrause - Platin gebürstet

34 459 980 Produktversion ab 6/1/2024

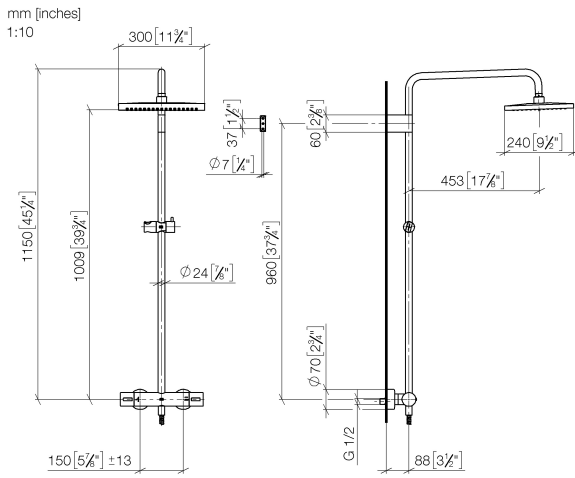

Durchflussdiagramm

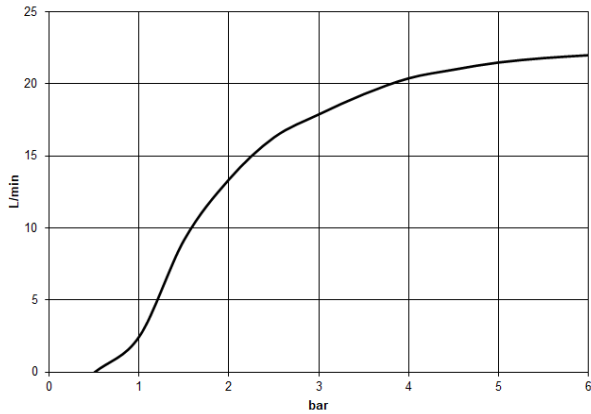

Codes & Standards

DIN 4109

EN 1717

ISO 3822

Scottish Water
Byelaws

UK Water Supply
Regulations

Ü-Zeichen



Shower Pipe mit Brause-Thermostat ohne Handbrause - Platin gebürstet

34 459 980 Produktversion ab 6/1/2024

Zertifikate

Belgaqua_21-032-2 WRAS_2204 LGA_38

Shower Pipe mit Brause-Thermostat ohne Handbrause - Platin gebürstet

34 459 980 Produktversion ab 6/1/2024

Ersatzteile für die
anderen
Oberflächenvarianten
finden Sie hier:
Chrom

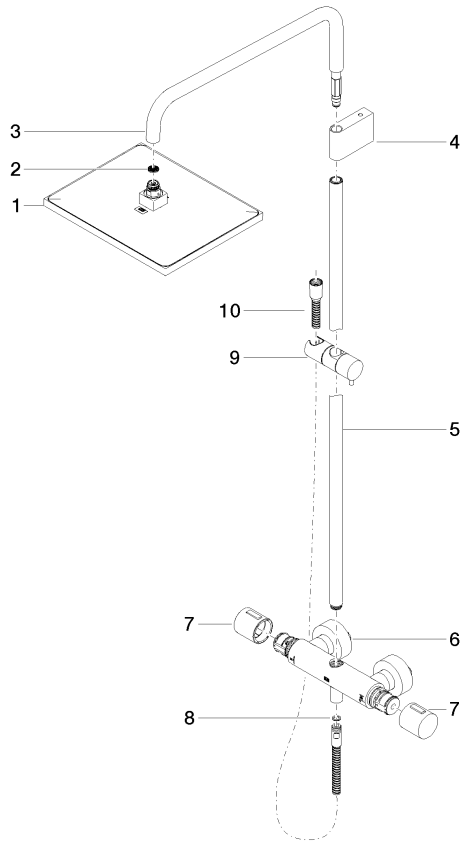

Ersatzteilstückliste

Nr.	Artikelnummer	Benennung	Verbaumenge	Lieferzeit
1	04 12 05 063 00-06	Brause	1	10
2	09 23 01 039 90	Sieb	1	2
3	90 28 22 348 00-06	Rohr	1	10
4	90 17 11 150 00-06	Halter	1	10
5	90 28 22 349 00-06	Rohr	1	10
6	04 17 01 250 00-06	Anschluss	1	10
7	90 17 33 015 00-06	Griff	2	10
8	90 14 20 026 00 90	Dichtung	1	2
9	12 570 970-06	Schieber - Platin gebürstet	1	10
10	28 322 970-06	Metall-Brauseschlauch 1/2" x 3/8" x 1750 mm - Platin gebürstet	1	2