

36 112 970



Passt zu: IMO, LULU, TARA, LISSÉ, VAIA, META













- Ausladung Standbrause 450 mm
- Kopfbrause: Regenstrahl
- Regenbrause Ø 220 mm
- Regenbrause mit Antikalk-System
- Durchfluss Regenbrause max. 14 l/min (bei 3 Bar)
- Höhe Armatur bis Regenbrause (Unterkante) 1010 mm
- Höhe Armatur bis Oberkante Bogen 1150 mm
- Metallbrauseschlauch 1750 mm mit integriertem Verdrehenschutz
- Anschluss 1/2"
- Wandrohr mit Schieber
- Rohrdurchmesser 23,5 mm
- automatische Umstellung Standbrause/ Handbrause
- mit Leerlauf-Funktion

Dieser Artikel enthält keine Handbrause!

Eigensicher gegen Rückfließen.

Dieser Artikel enthält keine Handbrause!

Eigensicher gegen Rückfließen.

	Platin gebürstet	36 112 970-06
	Chrom	36 112 970-00
	Platin	36 112 970-08
	Dark Chrome	36 112 970-19
	Light Gold gebürstet	36 112 970-27
	Messing gebürstet (23kt Gold)	36 112 970-28
	Schwarz matt	36 112 970-33
	Bronze gebürstet	36 112 970-42
	Champagne gebürstet (22kt Gold)	36 112 970-46
	Champagne (22kt Gold)	36 112 970-47
	Chrom gebürstet	36 112 970-93
	Dark Platinum gebürstet	36 112 970-99

36 112 970

Benötigtes Zubehör

	UP-Wandbefestigung - •Max. Einbautiefe 105 mm •Min. Einbautiefe 80 mm	35 050 970 90
---	--	---------------

Benötigtes Zubehör

	Handbrause - Platin gebürstet	28 012 979-06
---	--------------------------------------	---------------

Benötigtes Zubehör

	Handbrause - Platin gebürstet	28 017 979-06
---	--------------------------------------	---------------

Benötigtes Zubehör

	Handbrause - Platin gebürstet	28 018 979-06
---	--------------------------------------	---------------

Benötigtes Zubehör

	SERIENNEUTRAL Handbrause - Platin gebürstet	28 029 979-06 0010
---	--	--------------------

Benötigtes Zubehör

	SERIENNEUTRAL Handbrause - Platin gebürstet	28 027 979-06 0010
---	--	--------------------

Benötigtes Zubehör

	Handbrause - Platin gebürstet	28 016 979-06
---	--------------------------------------	---------------

Benötigtes Zubehör

	Handbrause FlowReduce - Platin gebürstet	28 016 979-06 0010
---	---	--------------------

Benötigtes Zubehör

	Handbrause FlowReduce - Platin gebürstet	28 012 979-06 0010
---	---	--------------------

Benötigtes Zubehör

	Handbrause FlowReduce - Platin gebürstet	28 018 979-06 0010
---	---	--------------------

Benötigtes Zubehör

	SERIENNEUTRAL Handbrause - Platin gebürstet	28 029 979-06
---	--	---------------

Benötigtes Zubehör

	SERIENNEUTRAL Handbrause - Platin gebürstet	28 025 979-06 0010
---	--	--------------------

36 112 970

mm [inches]
1:10

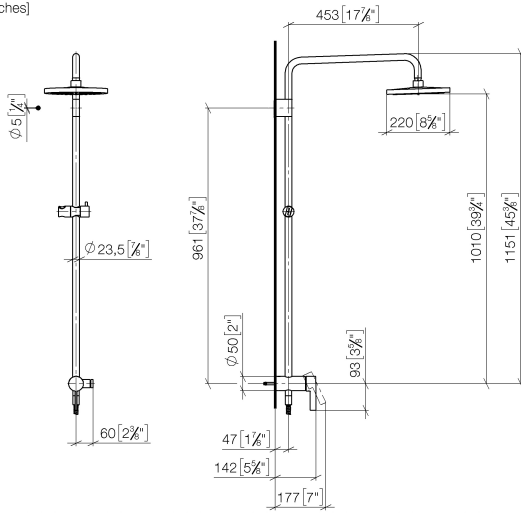

Durchflussdiagramm

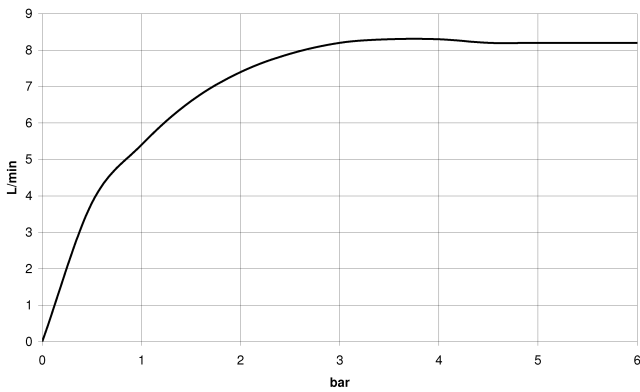

Codes & Standards

DIN 4109

EN 1717

EN 817

ISO 3822

Scottish Water
Byelaws

UK Water Supply
Regulations

Ü-Zeichen



Shower Pipe mit Brause-Einhandbatterie ohne Handbrause - Platin gebürstet

IMO

36 112 970

Zertifikate

DVGW_DW-
6512DN0

Belgaqua_21-025-2 LGA_38

WRAS_2101

36 112 970

Produktversion ab 4/1/2024





Shower Pipe mit Brause-Einhandbatterie ohne Handbrause - Platin gebürstet

IMO

36 112 970

Ersatzteilstückliste

Produktversion ab 4/1/2024

Nr.	Artikelnummer	Benennung	Verbaumenge	Lieferzeit
	04 12 05 092 00-06	Brause	9	10