

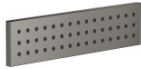













36 527 979



- HORIZONTAL RAIN, Durchfluss max. 9 l/min (bei 3 Bar)
- mit Antikalk-System
- Abdeckplatte 240 x 60 mm
- Anschluss 1/2"

Passt zu: IMO, LULU, MADISON, MEM, TARA, CL.1, LISSÉ, VAIA, META, CYO

	Dark Platinum gebürstet	36 527 979-99
	Chrom	36 527 979-00
	Platin gebürstet	36 527 979-06
	Platin	36 527 979-08
	Dark Chrome	36 527 979-19
	Light Gold	36 527 979-26
	Light Gold gebürstet	36 527 979-27
	Messing gebürstet (23kt Gold)	36 527 979-28
	Schwarz matt	36 527 979-33
	Bronze gebürstet	36 527 979-42
	Champagne gebürstet (22kt Gold)	36 527 979-46
	Champagne (22kt Gold)	36 527 979-47
	Chrom gebürstet	36 527 979-93

**Benötigtes Zubehör**



- UP-Wandeinbaukasten -** 35 206 970 90
- Max. Einbautiefe 173 mm
  - Min. Einbautiefe 100 mm

36 527 979

mm [inches]



**Durchflussdiagramm**



**Zertifikate**

LGA\_38672.

36 527 979

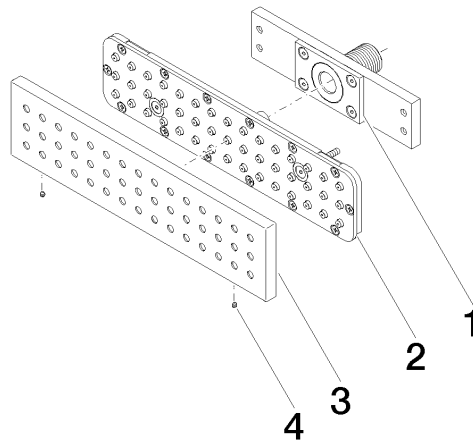

### Ersatzteilstückliste

Nr.	Artikelnummer	Benennung	Verbaumenge	Lieferzeit
1	90 11 02 137 00 90	Anschluss	1	2
2	90 11 02 332 01-00	Einsatz	1	10
3	09 27 99 001-99	Rosette	1	30
4	09 31 11 006 90	Stift	2	2