

ST 050 302 4892



- Ausladung Standbrause 452 mm
- Regenbrause: PURE RAIN, Durchfluss max. 7 l/min (bei 3 Bar)
- Funktion ab: 6 l/min
- Regenbrause Ø 220 mm
- Regenbrause mit Antikalk-System
- Handbrause: COMPACT RAIN, Durchfluss max. 15 l/min (bei 3 Bar)
- Drehumstellung mit Mengenregulierung und Absperrfunktion
- Schubrossetten Ø 70 mm
- Höhe Armatur bis Regenbrause (Unterkante) 964 mm
- Höhe Armatur bis Oberkante Bogen 1267 mm
- Stichmaß 150 mm ± 13 mm
- Metallbrauseschlauch 1750 mm mit integriertem Verdrehenschutz
- Anschluss 1/2"
- Wandrohr mit Schieber
- Rohrdurchmesser 23,5 mm

	Schwarz matt	ST 050 302 4892-33
	Chrom	ST 050 302 4892-00
	Platin gebürstet	ST 050 302 4892-06
	Platin	ST 050 302 4892-08
	Dark Chrome	ST 050 302 4892-19
	Messing gebürstet (23kt Gold)	ST 050 302 4892-28
	Champagne gebürstet (22kt Gold)	ST 050 302 4892-46
	Champagne (22kt Gold)	ST 050 302 4892-47
	Chrom gebürstet	ST 050 302 4892-93
	Dark Platinum gebürstet	ST 050 302 4892-99

Einzelkomponenten dieses Sets

Für dieses Set benötigen Sie folgende Komponenten

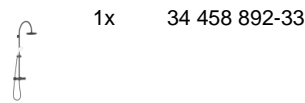
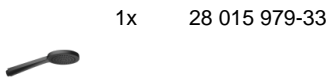



























ST 050 302 4892



- COMPACT RAIN, Durchfluss max. 15 l/min (bei 3 Bar)
- mit Antikalk-System
- Brausekopf Ø 100 mm
- Anschluss 1/2"

Eigensicher gegen Rückfließen.

Passt zu: IMO, LULU, MADISON, MEM, TARA, CL.1, LISSÉ, VAIA, META, CYO

	Schwarz matt	28 015 979-33
	Chrom	28 015 979-00
	Chrom	28 015 979-00 0010
	Platin gebürstet	28 015 979-06
	Platin gebürstet	28 015 979-06 0010
	Platin	28 015 979-08
	Platin	28 015 979-08 0010
	Dark Chrome	28 015 979-19
	Dark Chrome	28 015 979-19 0010
	Light Gold	28 015 979-26 0010
	Light Gold	28 015 979-26
	Light Gold gebürstet	28 015 979-27
	Light Gold gebürstet	28 015 979-27 0010
	Messing gebürstet (23kt Gold)	28 015 979-28
	Messing gebürstet (23kt Gold)	28 015 979-28 0010
	Schwarz matt	28 015 979-33 0010
	Bronze gebürstet	28 015 979-42
	Bronze gebürstet	28 015 979-42 0010
	Champagne gebürstet (22kt Gold)	28 015 979-46 0010
	Champagne gebürstet (22kt Gold)	28 015 979-46
	Champagne (22kt Gold)	28 015 979-47
	Champagne (22kt Gold)	28 015 979-47 0010
	Chrom gebürstet	28 015 979-93
	Chrom gebürstet	28 015 979-93 0010
	Dark Platinum gebürstet	28 015 979-99
	Dark Platinum gebürstet	28 015 979-99 0010

ST 050 302 4892

mm [inches]

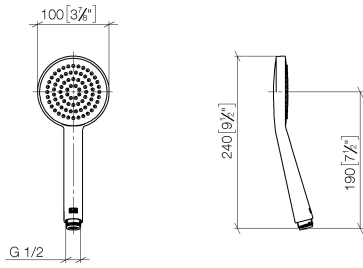

Durchflussdiagramm



Zertifikate

DVGW_DW-
6517DN0129.

WRAS_2009011.

LGA_29981.

ST 050 302 4892

Ersatzteile für die
anderen
Oberflächenvarianten
finden Sie hier:
Chrom

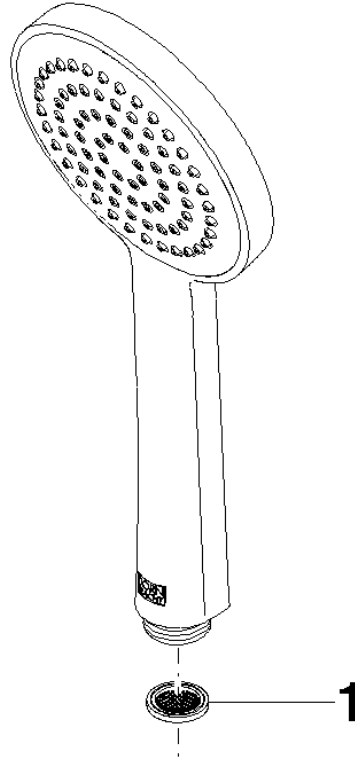

Ersatzteilstückliste

Nr.	Artikelnummer	Benennung	Verbaumenge	Lieferzeit
1	09 23 01 039 90	Sieb	1	2

ST 050 302 4892



- Ausladung Standbrause 452 mm
- Regenbrause: PURE RAIN, Durchfluss max. 7 l/min (bei 3 Bar)
- Funktion ab: 6 l/min
- Regenbrause Ø 220 mm
- Regenbrause mit Antikalk-System
- Drehumstellung mit Mengenregulierung und Absperrfunktion
- Schubrosetten Ø 70 mm
- Höhe Armatur bis Regenbrause (Unterkante) 964 mm
- Höhe Armatur bis Oberkante Bogen 1267 mm
- Stichmaß 150 mm ± 13 mm
- Metallbrauseschlauch 1750 mm mit integriertem Verdrehenschutz
- Anschluss 1/2"
- Wandrohr mit Schieber
- Rohrdurchmesser 23,5 mm
- Dieses Produkt leistet einen Beitrag zur Erfüllung der Vorgaben von nachhaltigen Gebäudezertifizierungen, z.B. LEED®, BREEAM®, DGNB

Dieser Artikel enthält keine Handbrause!

Eigensicher gegen Rückfließen.

	Schwarz matt	34 458 892-33
	Chrom	34 458 892-00
	Platin gebürstet	34 458 892-06
	Platin	34 458 892-08
	Dark Chrome	34 458 892-19
	Messing gebürstet (23kt Gold)	34 458 892-28
	Champagne gebürstet (22kt Gold)	34 458 892-46
	Champagne (22kt Gold)	34 458 892-47
	Chrom gebürstet	34 458 892-93
	Dark Platinum gebürstet	34 458 892-99

ST 050 302 4892

Benötigtes Zubehör

	Handbrause FlowReduce - Schwarz matt	28 016 979-33 0010
---	---	-----------------------

Benötigtes Zubehör

	Handbrause FlowReduce - Schwarz matt	28 016 979-33 0010
---	---	-----------------------

Benötigtes Zubehör

	Handbrause FlowReduce - Schwarz matt	28 012 979-33 0010
---	---	-----------------------

Benötigtes Zubehör

	Handbrause - Schwarz matt	28 017 979-33
---	----------------------------------	---------------

Benötigtes Zubehör

	Handbrause - Schwarz matt	28 016 979-33
---	----------------------------------	---------------

Benötigtes Zubehör

	Handbrause - Schwarz matt	28 016 979-33
---	----------------------------------	---------------

Benötigtes Zubehör

	Handbrause - Schwarz matt	28 012 979-33
---	----------------------------------	---------------

Benötigtes Zubehör

	Handbrause - Schwarz matt	28 018 979-33
---	----------------------------------	---------------

Benötigtes Zubehör

	Handbrause FlowReduce - Schwarz matt	28 018 979-33 0010
---	---	-----------------------

Benötigtes Zubehör

	SERIENNEUTRAL Handbrause - Schwarz matt	28 029 979-33 0010
---	--	-----------------------

Benötigtes Zubehör

	SERIENNEUTRAL Handbrause - Schwarz matt	28 029 979-33 0010
---	--	-----------------------

Benötigtes Zubehör

	SERIENNEUTRAL Handbrause - Schwarz matt	28 027 979-33 0010
---	--	-----------------------

Benötigtes Zubehör

	SERIENNEUTRAL Handbrause - Schwarz matt	28 029 979-33
---	--	---------------

Benötigtes Zubehör

	SERIENNEUTRAL Handbrause - Schwarz matt	28 029 979-33
---	--	---------------

Benötigtes Zubehör

	SERIENNEUTRAL Handbrause - Schwarz matt	28 025 979-33 0010
---	--	-----------------------

ST 050 302 4892

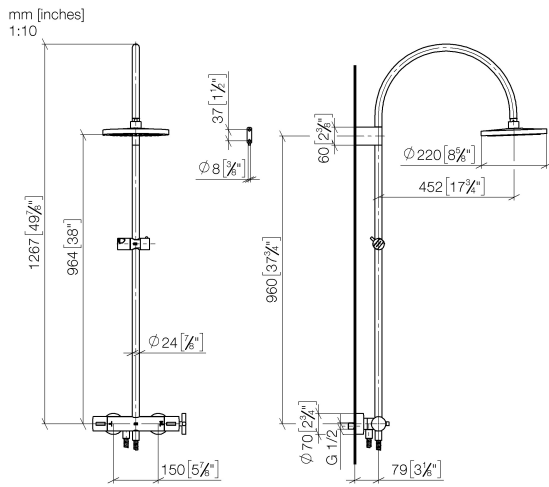

Durchflussdiagramm

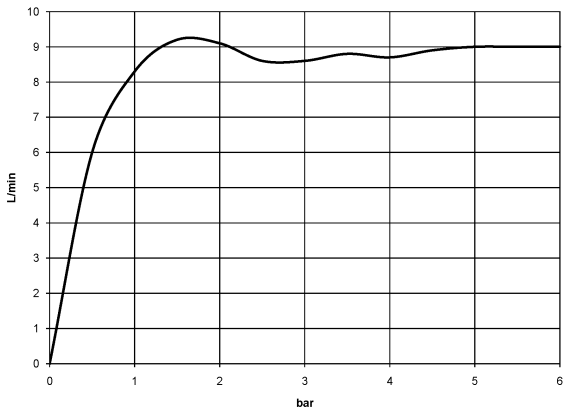

Zertifikate

Belgaqua_22_283_2 WRAS_2204013. LGA_38737.
7_8.

ST 050 302 4892

Ersatzteile für die
anderen
Oberflächenvarianten
finden Sie hier:
Chrom

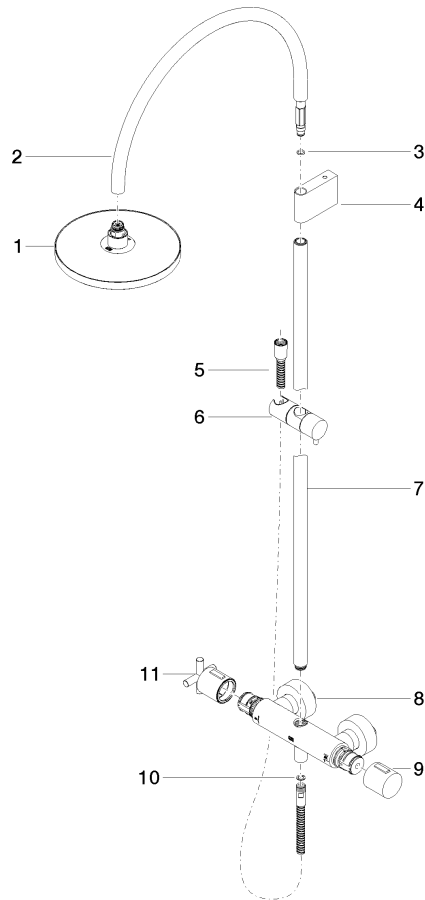

Ersatzteilstückliste

Nr.	Artikelnummer	Benennung	Verbaumenge	Lieferzeit
1	90 12 05 092 20-33	Brause	1	30
2	04 28 22 346 00-33	Rohr	1	60
3	09 14 10 008 90	Dichtung	1	2
4	90 17 11 150 00-33	Halter	1	30
5	28 322 970-33	Metall-Brauseschlauch 1/2" x 3/8" x 1750 mm - Schwarz matt	1	2
6	12 570 970-33	Schieber - Schwarz matt	1	30
7	90 28 22 349 00-33	Rohr	1	30
8	04 17 01 250 00-33	Anschluss	1	30
9	90 17 33 015 00-33	Griff	1	30
10	90 14 20 026 00 90	Dichtung	1	2
11	90 17 33 021 00-33	Griff	1	30