

ST 050 303 4892



- Ausladung Standbrause 420 mm
- Regenbrause: PURE RAIN, Durchfluss max. 7 l/min (bei 3 Bar)
- Regenbrause Ø 220 mm
- Regenbrause mit Antikalk-System
- Handbrause: COMPACT RAIN, Durchfluss max. 15 l/min (bei 3 Bar)
- Brausekopf Ø 100 mm
- Drehumstellung Standbrause/ Handbrause
- Höhe Armatur bis Regenbrause (Unterkante) 1007 mm
- Höhe Armatur bis Oberkante Bogen 1167 mm
- Rosette für Brausehalter Ø 55 mm
- Rosette für Wandbefestigung Ø 57 mm
- Rosette für Brausebatterie Ø 65 mm
- Stichmaß 150 mm ± 13 mm
- Metallbrauseschlauch 1500 mm
- Anschluss 1/2"
- Rohrdurchmesser 20 mm

	Chrom	ST 050 303 4892-00
	Platin gebürstet	ST 050 303 4892-06
	Platin	ST 050 303 4892-08
	Dark Chrome	ST 050 303 4892-19
	Light Gold gebürstet	ST 050 303 4892-27
	Messing gebürstet (23kt Gold)	ST 050 303 4892-28
	Schwarz matt	ST 050 303 4892-33
	Bronze gebürstet	ST 050 303 4892-42
	Champagne gebürstet (22kt Gold)	ST 050 303 4892-46
	Champagne (22kt Gold)	ST 050 303 4892-47
	Chrom gebürstet	ST 050 303 4892-93
	Dark Platinum gebürstet	ST 050 303 4892-99

Einzelkomponenten dieses Sets

Für dieses Set benötigen Sie folgende Komponenten



1x 26 633 892-00



1x 28 018 979-00

ST 050 303 4892



- Ausladung Standbrause 420 mm
- Kopfbrause: Regenstrahl
- Regenbrause Ø 220 mm
- Regenbrause mit Antikalk-System
- Durchfluss Regenbrause max. 7 l/min (bei 3 Bar)
- Drehumstellung Standbrause/ Handbrause
- Höhe Armatur bis Regenbrause (Unterkante) 1007 mm
- Höhe Armatur bis Oberkante Bogen 1167 mm
- Rosette für Brausehalter Ø 55 mm
- Rosette für Wandbefestigung Ø 57 mm
- Rosette für Brausebatterie Ø 65 mm
- Stichmaß 150 mm ± 13 mm
- Metallbrauseschlauch 1500 mm
- Anschluss 1/2"
- Rohrdurchmesser 20 mm
- mit Leerlauf-Funktion
- Dieses Produkt leistet einen Beitrag zur Erfüllung der Vorgaben von nachhaltigen Gebäudezertifizierungen, z.B. LEED®, BREEAM®, DGNB

Dieser Artikel enthält keine Handbrause!
Eigensicher gegen Rückfließen.

	Chrom	26 633 892-00
	Platin gebürstet	26 633 892-06
	Platin	26 633 892-08
	Dark Chrome	26 633 892-19
	Messing gebürstet (23kt Gold)	26 633 892-28
	Schwarz matt	26 633 892-33
	Champagne gebürstet (22kt Gold)	26 633 892-46
	Champagne (22kt Gold)	26 633 892-47
	Chrom gebürstet	26 633 892-93
	Dark Platin gebürstet	26 633 892-99

Benötigtes Zubehör

	Handbrause - Chrom	28 015 979-00
--	---------------------------	---------------

Benötigtes Zubehör

	Handbrause - Chrom	28 012 979-00
--	---------------------------	---------------

Benötigtes Zubehör

	Handbrause - Chrom	28 017 979-00
--	---------------------------	---------------

Benötigtes Zubehör

	Handbrause - Chrom	28 018 979-00
--	---------------------------	---------------

Benötigtes Zubehör

	SERIENNEUTRAL Handbrause - Chrom	28 027 979-00 0010
--	---	-----------------------

Benötigtes Zubehör

	SERIENNEUTRAL Handbrause - Chrom	28 025 979-00 0010
--	---	-----------------------

Benötigtes Zubehör

	Handbrause - Chrom	28 016 979-00
--	---------------------------	---------------

Benötigtes Zubehör

	Handbrause FlowReduce - Chrom	28 016 979-00 0010
--	--------------------------------------	-----------------------

Benötigtes Zubehör

	Handbrause FlowReduce - Chrom	28 012 979-00 0010
--	--------------------------------------	-----------------------

Benötigtes Zubehör

	Handbrause FlowReduce - Chrom	28 018 979-00 0010
--	--------------------------------------	-----------------------

Benötigtes Zubehör

	SERIENNEUTRAL Handbrause - Chrom	28 029 979-00 0010
--	---	-----------------------

Durchflussdiagramm

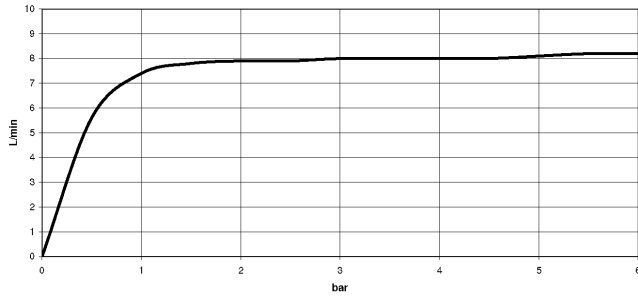

Zertifikate

Belgaqua_21-023- WRAS_2204012. LGA_38735.
27_8.

ST 050 303 4892

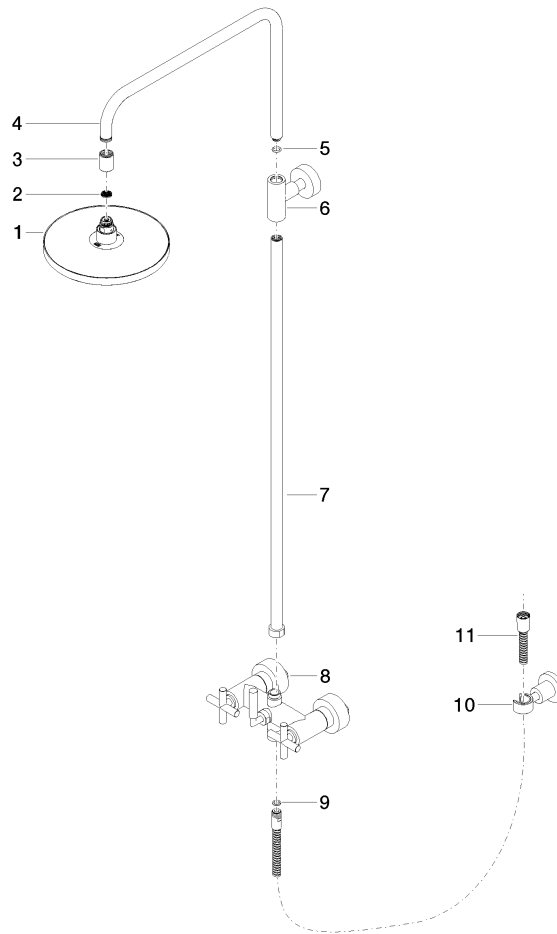

Ersatzteilstückliste

Nr.	Artikelnummer	Benennung	Verbaumenge	Lieferzeit
1	90 12 05 092 20-00	Brause	1	10
2	09 23 01 039 90	Sieb	1	2
3	09 24 03 177 20-00	Adapter	1	10
4	04 28 22 101 20-00	Auslauf	1	10
5	90 14 10 011 00 90	Dichtung	1	2
6	90 17 11 037 00-00	Halter	1	10
7	90 28 22 096 00-00	Rohr	1	10
8	04 17 10 020 01-00	Armatur	1	10
9	90 14 20 026 00 90	Dichtung	1	2
10	28 050 892-00	TARA Brausehalter - Chrom	1	10
11	28 304 970-00	Metall-Brauseschlauch 1/2" x 3/8" x 1500 mm - Chrom	1	2





























ST 050 303 4892



- Dreifach bzw. fünffach verstellbar: COMPACT RAIN, COMPACT SOFT FLOW, COMPACT AQUAPRESSURE FLOW, Durchfluss max. 15 l/min (bei 3 Bar)
- mit Antikalk-System
- Brausekopf Ø 100 mm
- Anschluss 1/2"
- Funktion ab: 7 l/min

Eigensicher gegen Rückfließen.

Passt zu: IMO, LULU, MADISON, MEM, TARA, CL.1, LISSÉ, VAIA, META, CYO

	Chrom	28 018 979-00
	Chrom	28 018 979-00 0010
	Platin gebürstet	28 018 979-06
	Platin gebürstet	28 018 979-06 0010
	Platin	28 018 979-08
	Platin	28 018 979-08 0010
	Dark Brass matt	28 018 979-16 0010
	Dark Bronze matt	28 018 979-17 0010
	Dark Chrome	28 018 979-19
	Dark Chrome	28 018 979-19 0010
	Light Gold	28 018 979-26 0010
	Light Gold	28 018 979-26
	Light Gold gebürstet	28 018 979-27 0010
	Light Gold gebürstet	28 018 979-27
	Messing gebürstet (23kt Gold)	28 018 979-28
	Messing gebürstet (23kt Gold)	28 018 979-28 0010
	Schwarz matt	28 018 979-33
	Schwarz matt	28 018 979-33 0010
	Bronze gebürstet	28 018 979-42
	Bronze gebürstet	28 018 979-42 0010
	Champagne gebürstet (22kt Gold)	28 018 979-46
	Champagne gebürstet (22kt Gold)	28 018 979-46 0010
	Champagne (22kt Gold)	28 018 979-47
	Champagne (22kt Gold)	28 018 979-47 0010
	Chrom gebürstet	28 018 979-93
	Chrom gebürstet	28 018 979-93 0010
	Dark Platinum gebürstet	28 018 979-99
	Dark Platinum gebürstet	28 018 979-99 0010

ST 050 303 4892

mm [inches]

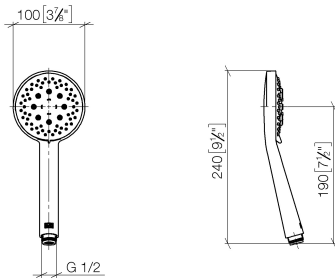

Durchflussdiagramm



Zertifikate

LGA_29984.

DVGW_DW-
6517DN0129.

WRAS_2210003.

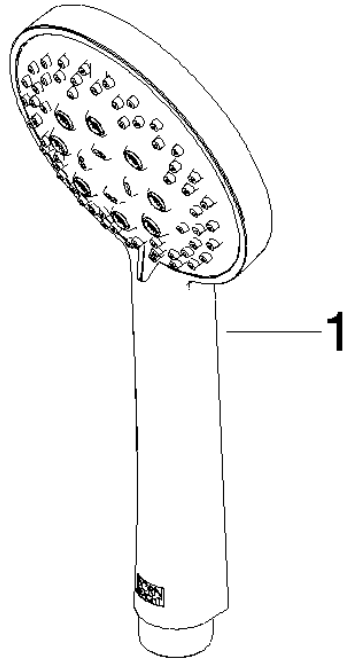

Ersatzteilstückliste

Nr.	Artikelnummer	Benennung	Verbaumenge	Lieferzeit
1	09 23 01 039 90	Sieb	1	2