

**TARA Shower Pipe mit Brause-Thermostat 220 mm - Messing gebürstet (23kt Gold)**

TARA

ST 050 304 8892



- Ausladung Standbrause 452 mm
- Regenbrause: PURE RAIN, Durchfluss max. 7 l/min (bei 3 Bar)
- Regenbrause Ø 220 mm
- Regenbrause mit Antikalk-System
- Handbrause: COMPACT RAIN, Durchfluss max. 15 l/min (bei 3 Bar)
- Brausekopf Ø 100 mm
- Drehumstellung mit Mengenregulierung und Absperrfunktion
- Schubrosetten Ø 70 mm
- Höhe Armatur bis Regenbrause (Unterkante) 963 mm
- Höhe Armatur bis Oberkante Bogen 1267 mm
- Stichmaß 150 mm ± 13 mm
- Metallbrauseschlauch 1750 mm mit integriertem Verdreherschutz
- Anschluss 1/2"
- Wandrohr mit Schieber
- Rohrdurchmesser 23,5 mm

	Messing gebürstet (23kt Gold)	ST 050 304 8892-28
	Chrom	ST 050 304 8892-00
	Platin gebürstet	ST 050 304 8892-06
	Platin	ST 050 304 8892-08
	Schwarz matt	ST 050 304 8892-33
	Champagne gebürstet (22kt Gold)	ST 050 304 8892-46
	Champagne (22kt Gold)	ST 050 304 8892-47
	Dark Platinum gebürstet	ST 050 304 8892-99

**Einzelkomponenten dieses Sets**

Für dieses Set benötigen Sie folgende Komponenten



1x 34 459 892-28



1x 28 015 979-28



TARA Shower Pipe mit Brause-Thermostat 220 mm - Messing gebürstet (23kt Gold)

---

TARA

ST 050 304 8892

ST 050 304 8892



Passt zu: TARA, VAIA, META

- Ausladung Standbrause 452 mm
- Kopfbrause: Regenstrahl
- Regenbrause Ø 220 mm
- Regenbrause mit Antikalk-System
- Durchfluss Regenbrause max. 7 l/min (bei 3 Bar)
- Drehumstellung mit Mengenregulierung und Absperrfunktion
- Schubrosetten Ø 70 mm
- Höhe Armatur bis Regenbrause (Unterkante) 963 mm
- Höhe Armatur bis Oberkante Bogen 1267 mm
- Stichmaß 150 mm ± 13 mm
- Metallbrauseschlauch 1750 mm mit integriertem Verdrehenschutz
- Anschluss 1/2"
- Wandrohr mit Schieber
- Rohrdurchmesser 23,5 mm
- mit Leerlauf-Funktion
- Dieses Produkt leistet einen Beitrag zur Erfüllung der Vorgaben von nachhaltigen Gebäudezertifizierungen, z.B. LEED®, BREEAM®, DGNB

Dieser Artikel enthält keine Handbrause!  
Eigensicher gegen Rückfließen.

	Messing gebürstet (23kt Gold)	34 459 892-28
	Chrom	34 459 892-00
	Platin gebürstet	34 459 892-06
	Platin	34 459 892-08
	Dark Chrome	34 459 892-19
	Light Gold gebürstet	34 459 892-27
	Schwarz matt	34 459 892-33
	Bronze gebürstet	34 459 892-42
	Champagne gebürstet (22kt Gold)	34 459 892-46
	Champagne (22kt Gold)	34 459 892-47
	Chrom gebürstet	34 459 892-93
	Dark Platinum gebürstet	34 459 892-99

**Benötigtes Zubehör**

	<b>Handbrause - Messing gebürstet (23kt Gold)</b>	28 018 979-28
--	---	---------------

**Benötigtes Zubehör**

	<b>Handbrause - Messing gebürstet (23kt Gold)</b>	28 017 979-28
--	---	---------------

**Benötigtes Zubehör**

	<b>Handbrause FlowReduce - Messing gebürstet (23kt Gold)</b>	28 012 979-28 0010
--	--	--------------------

**Benötigtes Zubehör**

	<b>Handbrause FlowReduce - Messing gebürstet (23kt Gold)</b>	28 018 979-28 0010
--	--	--------------------

**Benötigtes Zubehör**

	<b>Handbrause - Messing gebürstet (23kt Gold)</b>	28 016 979-28
--	---	---------------

**Benötigtes Zubehör**

	<b>Handbrause - Messing gebürstet (23kt Gold)</b>	28 012 979-28
--	---	---------------

**Benötigtes Zubehör**

	<b>Handbrause FlowReduce - Messing gebürstet (23kt Gold)</b>	28 016 979-28 0010
--	--	--------------------

ST 050 304 8802  
mm [inches]  
M 1:10

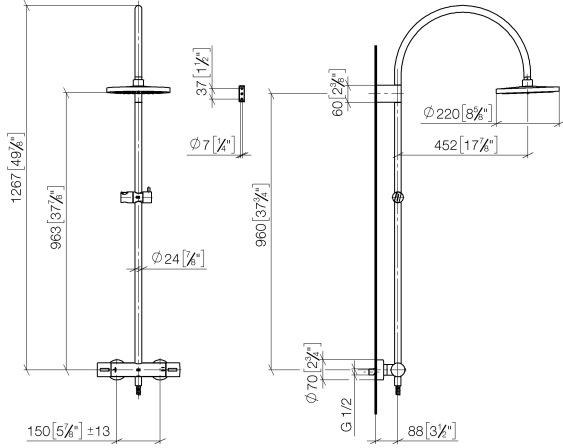

**Durchflussdiagramm**

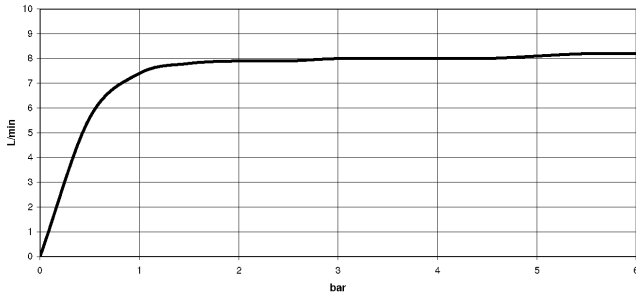

**Zertifikate**

Belgaqua\_21-032- WRAS\_2204013. LGA\_38737.  
27\_5.

ST 050 304 8892

Ersatzteile für die  
anderen  
Oberflächenvarianten  
finden Sie hier:  
Chrom

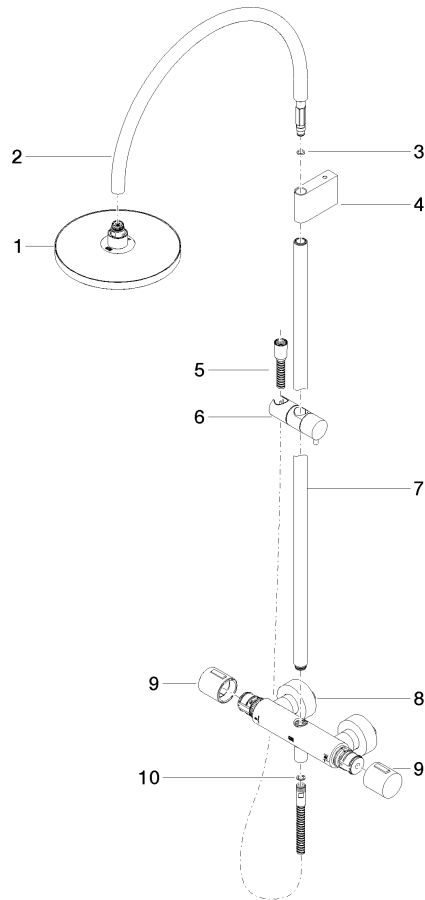

**Ersatzteilstückliste**

Nr.	Artikelnummer	Benennung	Verbaumenge	Lieferzeit
1	90 12 05 092 20-28	Brause	1	20
2	04 28 22 346 00-28	Rohr	1	20
3	09 14 10 008 90	Dichtung	1	2
4	90 17 11 150 00-28	Halter	1	20
5	28 322 970-28	Metall-Brauseschlauch 1/2" x 3/8" x 1750 mm - Messing gebürstet (23kt Gold)	1	20
6	12 570 970-28	Schieber - Messing gebürstet (23kt Gold)	1	20
7	90 28 22 349 00-28	Rohr	1	20
8	04 17 01 250 00-28	Anschluss	1	20
9	90 17 33 015 00-28	Griff	1	20
10	90 14 20 026 00 90	Dichtung	1	2

**TARA Shower Pipe mit Brause-Thermostat 220 mm - Messing gebürstet (23kt Gold)**

TARA

























ST 050 304 8892



- COMPACT RAIN, Durchfluss max. 15 l/min (bei 3 Bar)
- mit Antikalk-System
- Brausekopf Ø 100 mm
- Anschluss 1/2"

Eigensicher gegen Rückfließen.

Passt zu: IMO, LULU, MADISON, MEM, TARA, CL.1, LISSÉ, VAIA, META, CYO

	Messing gebürstet (23kt Gold)	28 015 979-28
	Chrom	28 015 979-00
	Chrom	28 015 979-00 0010
	Platin gebürstet	28 015 979-06
	Platin gebürstet	28 015 979-06 0010
	Platin	28 015 979-08
	Platin	28 015 979-08 0010
	Dark Chrome	28 015 979-19
	Dark Chrome	28 015 979-19 0010
	Light Gold	28 015 979-26 0010
	Light Gold	28 015 979-26
	Light Gold gebürstet	28 015 979-27
	Light Gold gebürstet	28 015 979-27 0010
	Messing gebürstet (23kt Gold)	28 015 979-28 0010
	Schwarz matt	28 015 979-33
	Schwarz matt	28 015 979-33 0010
	Bronze gebürstet	28 015 979-42
	Bronze gebürstet	28 015 979-42 0010
	Champagne gebürstet (22kt Gold)	28 015 979-46 0010
	Champagne gebürstet (22kt Gold)	28 015 979-46
	Champagne (22kt Gold)	28 015 979-47
	Champagne (22kt Gold)	28 015 979-47 0010
	Chrom gebürstet	28 015 979-93
	Chrom gebürstet	28 015 979-93 0010
	Dark Platin gebürstet	28 015 979-99
	Dark Platin gebürstet	28 015 979-99 0010





TARA Shower Pipe mit Brause-Thermostat 220 mm - Messing gebürstet (23kt Gold)

---

TARA

ST 050 304 8892





TARA Shower Pipe mit Brause-Thermostat 220 mm - Messing gebürstet (23kt Gold)

---

TARA

ST 050 304 8892

ST 050 304 8892  
mm [inches]

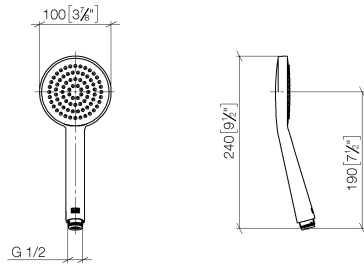

**Durchflussdiagramm**

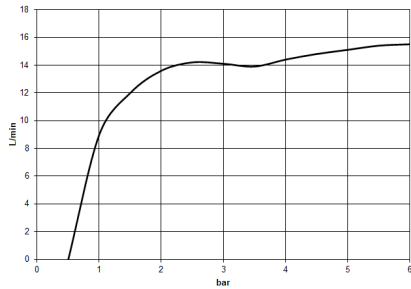

**Zertifikate**

DVGW\_DW-6517DN0129. WRAS\_2009011. LGA\_29981.

ST 050 304 8892

Ersatzteile für die  
anderen  
Oberflächenvarianten  
finden Sie hier:  
Chrom

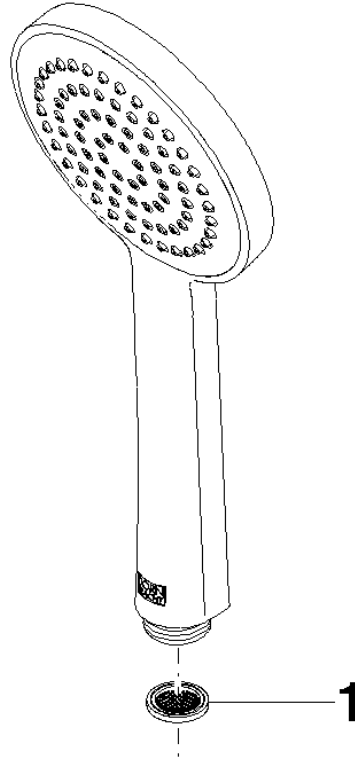

### Ersatzteilstückliste

Nr.	Artikelnummer	Benennung	Verbaumenge	Lieferzeit
1	09 23 01 039 90	Sieb	1	2