

ST 050 308 4892



- Ausladung Standbrause 420 mm
- Regenbrause: PURE RAIN, Durchfluss max. 14 l/min (bei 3 Bar)
- Funktion ab: 10 l/min
- Regenbrause Ø 300 mm
- Regenbrause mit Antikalk-System
- Handbrause: COMPACT RAIN, Durchfluss max. 15 l/min (bei 3 Bar)
- Brausekopf Ø 100 mm
- Drehumstellung Standbrause/ Handbrause
- Höhe Armatur bis Regenbrause (Unterkante) 850 mm
- Höhe Armatur bis Oberkante Bogen 1167 mm
- Rosette für Brausehalter Ø 55 mm
- Rosette für Wandbefestigung Ø 57 mm
- Rosette für Brausebatterie Ø 65 mm
- Stichmaß 150 mm ± 13 mm
- Metallbrauseschlauch 1500 mm
- Anschluss 1/2"
- Rohrdurchmesser 20 mm

	Dark Chrome	ST 050 308 4892-19
	Chrom	ST 050 308 4892-00
	Platin gebürstet	ST 050 308 4892-06
	Platin	ST 050 308 4892-08
	Messing gebürstet (23kt Gold)	ST 050 308 4892-28
	Schwarz matt	ST 050 308 4892-33
	Champagne gebürstet (22kt Gold)	ST 050 308 4892-46
	Champagne (22kt Gold)	ST 050 308 4892-47
	Chrom gebürstet	ST 050 308 4892-93
	Dark Platinum gebürstet	ST 050 308 4892-99

**Einzelkomponenten dieses Sets**

Für dieses Set benötigen Sie folgende Komponenten



1x 28 018 979-19



1x 26 622 892-19































ST 050 308 4892



- Dreifach bzw. fünffach verstellbar: COMPACT RAIN, COMPACT SOFT FLOW, COMPACT AQUAPRESSURE FLOW, Durchfluss max. 15 l/min (bei 3 Bar)
- mit Antikalk-System
- Brausekopf Ø 100 mm
- Anschluss 1/2"
- Funktion ab: 7 l/min

Eigensicher gegen Rückfließen.

Passt zu: IMO, LULU, MADISON, MEM, TARA, CL.1, LISSÉ, VAIA, META, CYO

	Dark Chrome	28 018 979-19
	Chrom	28 018 979-00
	Chrom	28 018 979-00 0010
	Platin gebürstet	28 018 979-06
	Platin gebürstet	28 018 979-06 0010
	Platin	28 018 979-08
	Platin	28 018 979-08 0010
	Dark Brass matt	28 018 979-16 0010
	Dark Bronze matt	28 018 979-17 0010
	Dark Chrome	28 018 979-19 0010
	Light Gold	28 018 979-26 0010
	Light Gold	28 018 979-26
	Light Gold gebürstet	28 018 979-27 0010
	Light Gold gebürstet	28 018 979-27
	Messing gebürstet (23kt Gold)	28 018 979-28
	Messing gebürstet (23kt Gold)	28 018 979-28 0010
	Schwarz matt	28 018 979-33
	Schwarz matt	28 018 979-33 0010
	Bronze gebürstet	28 018 979-42
	Bronze gebürstet	28 018 979-42 0010
	Champagne gebürstet (22kt Gold)	28 018 979-46
	Champagne gebürstet (22kt Gold)	28 018 979-46 0010
	Champagne (22kt Gold)	28 018 979-47
	Champagne (22kt Gold)	28 018 979-47 0010
	Chrom gebürstet	28 018 979-93
	Chrom gebürstet	28 018 979-93 0010
	Dark Platinum gebürstet	28 018 979-99
	Dark Platinum gebürstet	28 018 979-99 0010





## TARA Shower Pipe mit Brausebatterie 300 mm - Dark Chrome

---

TARA

ST 050 308 4892

ST 050 308 4892

mm [inches]

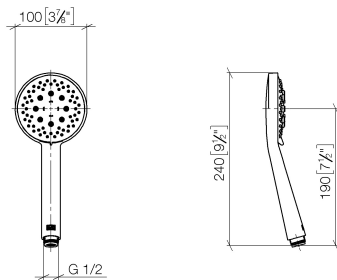

**Durchflussdiagramm**

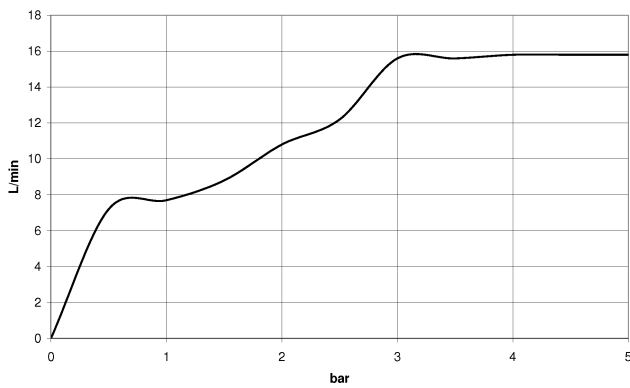

**Zertifikate**

LGA\_29984.

DVGW\_DW-  
6517DN0129.

WRAS\_2210003.

ST 050 308 4892

Ersatzteile für die  
anderen  
Oberflächenvarianten  
finden Sie hier:  
Chrom

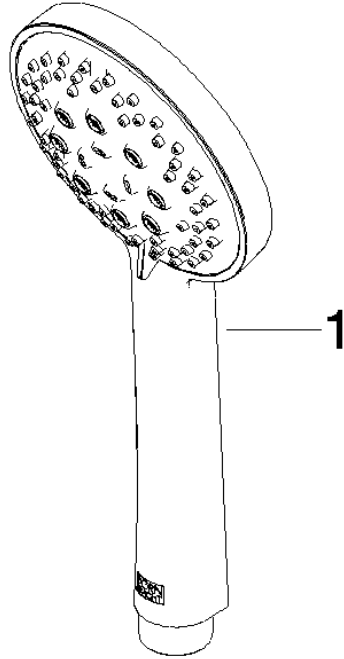

### Ersatzteilstückliste

Nr.	Artikelnummer	Benennung	Verbaumenge	Lieferzeit
1	09 23 01 039 90	Sieb	1	2

ST 050 308 4892



- Ausladung Standbrause 420 mm
- Kopfbrause: Regenstrahl
- Regenbrause Ø 300 mm
- Regenbrause mit Antikalk-System
- Durchfluss Regenbrause max. 14 l/min (bei 3 Bar)
- Funktion ab: 10 l/min
- Drehumstellung Standbrause/ Handbrause
- Höhe Armatur bis Regenbrause (Unterkante) 850 mm
- Höhe Armatur bis Oberkante Bogen 1167 mm
- Rosette für Brausehalter Ø 55 mm
- Rosette für Wandbefestigung Ø 57 mm
- Rosette für Brausebatterie Ø 65 mm
- Stichmaß 150 mm ± 13 mm
- Metallbrauseschlauch 1500 mm
- Anschluss 1/2"
- Rohrdurchmesser 20 mm
- mit Leerlauf-Funktion

Dieser Artikel enthält keine Handbrause!

Eigensicher gegen Rückfließen.

	Dark Chrome	26 622 892-19
	Chrom	26 622 892-00
	Platin gebürstet	26 622 892-06
	Platin	26 622 892-08
	Messing gebürstet (23kt Gold)	26 622 892-28
	Schwarz matt	26 622 892-33
	Champagne gebürstet (22kt Gold)	26 622 892-46
	Champagne (22kt Gold)	26 622 892-47
	Chrom gebürstet	26 622 892-93
	Dark Platinum gebürstet	26 622 892-99





ST 050 308 4892

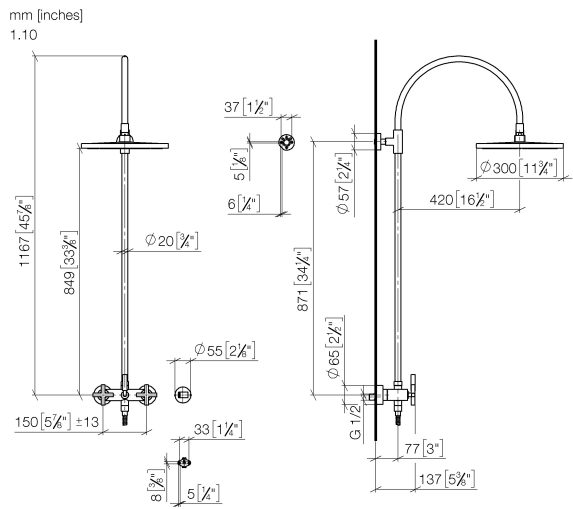

### Durchflussdiagramm

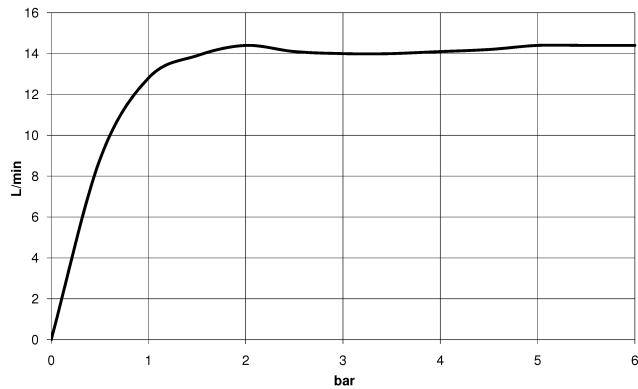

### Zertifikate

Belgaqua\_24-004- LGA\_38664.  
27\_8.

ST 050 308 4892

Ersatzteile für die  
anderen  
Oberflächenvarianten  
finden Sie hier:  
Chrom

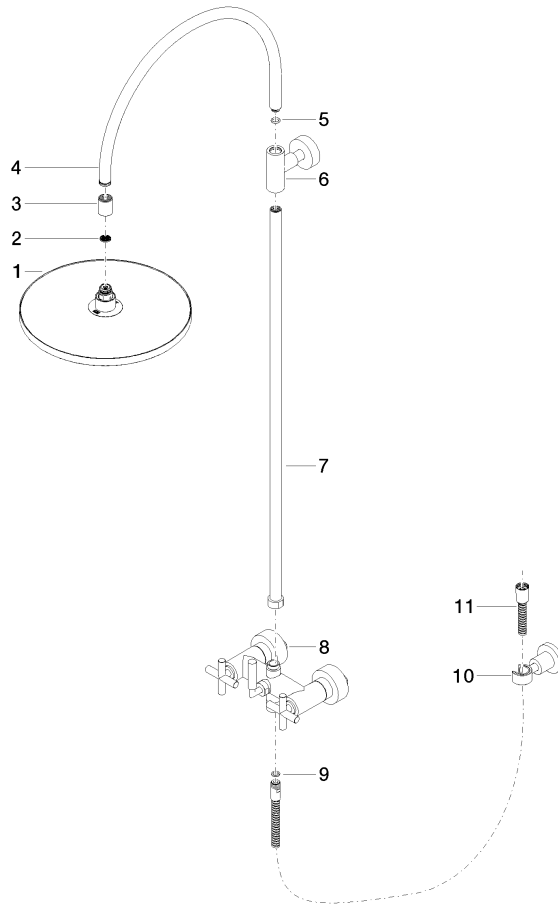

### Ersatzteilstückliste

Nr.	Artikelnummer	Benennung	Verbaumenge	Lieferzeit
1	04 12 05 091 00-19	Brause	1	20
2	09 23 01 039 90	Sieb	1	2
3	09 24 03 177 20-19	Adapter	1	20
4	04 28 22 097 20-19	Auslauf	1	20
5	90 14 10 011 00 90	Dichtung	1	2
6	90 17 11 037 00-19	Halter	1	20
7	90 28 22 096 00-19	Rohr	1	20
8	04 17 10 020 01-19	Armatur	1	20
9	90 14 20 026 00 90	Dichtung	1	2
10	28 050 892-19	TARA Brausehalter - Dark Chrome	1	20
11	28 304 970-19	Metall-Brauseschlauch 1/2" x 3/8" x 1500 mm - Dark Chrome	1	20