









MEM Single-lever bath mixer with stand pipe for free-standing assembly with hand shower set - Brushed Durabronz (23kt Gold)

MEM

25 863 782



- 281mm projection
- spout: cascade
- max. flow 25.1 l/min at 3 bar flow pressure
- Hand shower: COMPACT RAIN, max. flow rate 6.8 l/min (at 3 bar)
- bar-type hand shower with anti-scale system
- wall bracket
- automatic bath/shower diverter
- total height 1139 - 1209 mm
- stand pipe height 598 - 668 mm
- height up to aerator 968 – 1038 mm
- push-on rosette 131 x 131 mm
- metal shower hose 1250mm with integrated anti-twist protection
- WRAS 240502007

	Brushed Durabronz (23kt Gold)	25 863 782-28
	Chrome	25 863 782-00
	Brushed Platinum	25 863 782-06
	Platinum	25 863 782-08
	Dark Chrome	25 863 782-19
	Brushed Champagne (22kt Gold)	25 863 782-46
	Champagne (22kt Gold)	25 863 782-47
	Brushed Dark Platinum	25 863 782-99

Required miscellaneous



- Concealed floor mounting -**
- max. recess depth 150 mm
 - min. recess depth 80 mm

35 945 970 90

MEM Single-lever bath mixer with stand pipe for free-standing assembly with hand shower set - Brushed Durabronz (23kt Gold)

MEM

25 863 782

mm [inches]
1:5

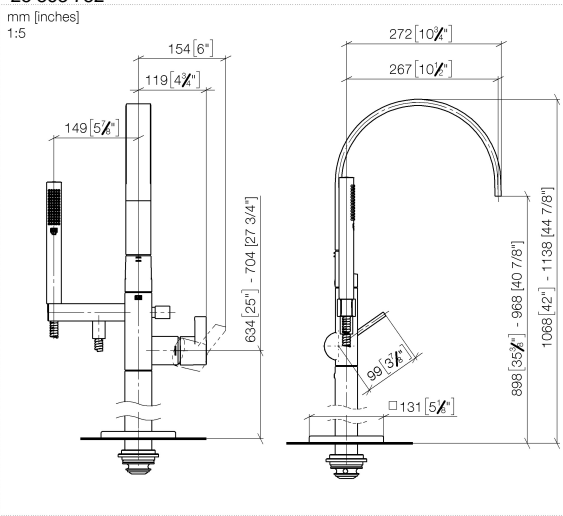

Flow rate chart

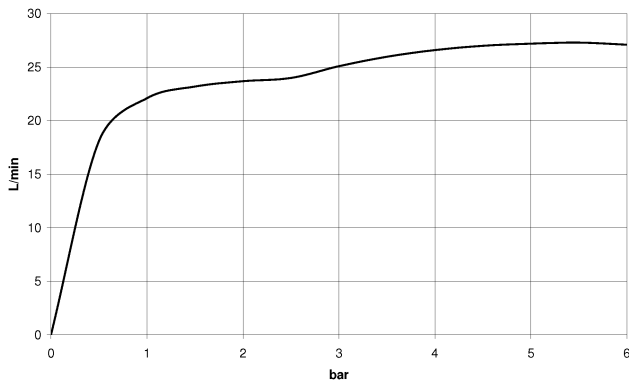

Codes & Standards

DIN 4109

ISO 3822

Scottish Water
Byelaws

UK Water Supply
Regulations

Ü-Zeichen



MEM Single-lever bath mixer with stand pipe for free-standing assembly with
hand shower set - Brushed Durabronz (23kt Gold)

MEM

25 863 782

Certificates

LGA_38

WRAS_240502

MEM Single-lever bath mixer with stand pipe for free-standing assembly with hand shower set - Brushed Durabronz (23kt Gold)

MEM

25 863 782





MEM Single-lever bath mixer with stand pipe for free-standing assembly with hand shower set - Brushed Durabronz (23kt Gold)

MEM

25 863 782

Spare parts list

No.	Item Number	Name	Quantity used	Delivery time
	90 12 11 140 30-28	shower	46	20