

# MADISON Showerpipe with shower mixer without hand shower - Durabross (23kt Gold)

MADISON



26 632 360



- shower with fixed riser projection 420mm
- overhead shower: rain flow
- rain shower Ø 200 mm
- max. rainshower flow 14 l/min
- Function from: 8 l/min
- rotary diverter for fixed-riser shower/hand shower
- height of fittings up to top edge of elbow 1180mm
- height of fittings up to rain shower (bottom edge) 1009mm
- rosette for shower holder Ø 66mm
- rosette for wall mounting Ø 70mm
- rosette for shower mixer Ø 60mm
- gauge 150 mm - 13 mm
- metal shower hose 1250mm with integrated anti-twist protection
- 1/2" connection
- Pipe diameter 20 mm
- This product can help a building meet the requirements of Green Building Rating Systems, e.g. LEED®, BREEAM®, DGNB
- WRAS 2204012

This article does not include a hand shower!

Intrinsic protection against back flow.

	Durabross (23kt Gold)	26 632 360-09
	Chrome	26 632 360-00
	Brushed Platinum	26 632 360-06
	Platinum	26 632 360-08
	Brushed Durabross (23kt Gold)	26 632 360-28
	Brushed Dark Platinum	26 632 360-99

## Required miscellaneous

	<b>MADISON Hand shower - Durabross (23kt Gold)</b>	28 002 978-09
	<ul style="list-style-type: none"> <li>• spray head Ø 95mm</li> <li>• Hand shower see page {PAGE}</li> <li>• Three settings: COMPACT RAIN, COMPACT SOFT FLOW, COMPACT AQUAPRESSURE FLOW, max. flow rate l/min (at 3 bar)</li> </ul>	

## Required miscellaneous

	<b>MADISON Metal hand shower with porcelain insert (white) FlowReduce - Durabross (23kt Gold)</b>	28 002 970-09 0010
---	---	-----------------------

## Required miscellaneous

	<b>MADISON Hand shower FlowReduce - Durabross (23kt Gold)</b>	28 002 978-09 0010
	<ul style="list-style-type: none"> <li>• spray head Ø 95mm</li> <li>• Hand shower see page {PAGE}</li> <li>• Three settings: COMPACT RAIN, COMPACT SOFT FLOW, COMPACT AQUAPRESSURE FLOW, max. flow rate l/min (at 3 bar)</li> </ul>	

**MADISON Showerpipe with shower mixer without hand shower - Durabross (23kt Gold)**

MADISON

26 632 360  
mm [inches]

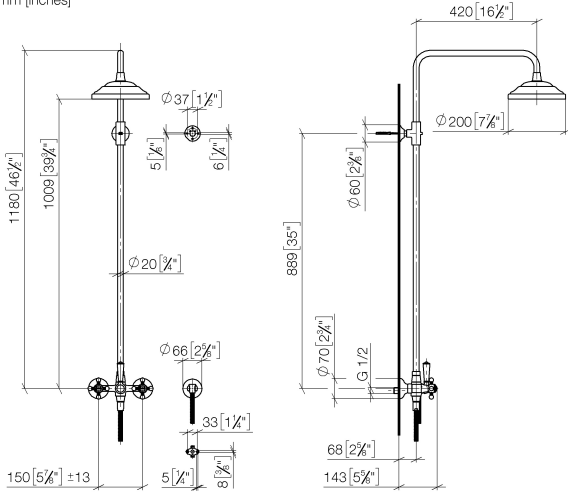

**Flow rate chart**

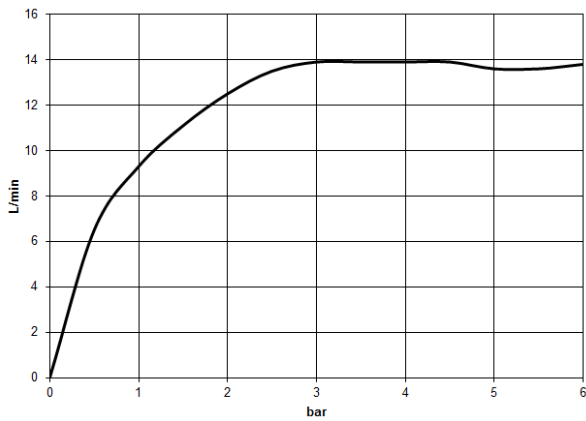

**Codes & Standards**

DIN 4109

EN 1717

ISO 3822

Scottish Water  
Byelaws

UK Water Supply  
Regulations

Ü-Zeichen



MADISON Showerpipe with shower mixer without hand shower - Durabrass  
(23kt Gold)

---

MADISON

26 632 360

Certificates

---

Belgaqua\_21-023-2 WRAS\_2204

LGA\_29

26 632 360

Parts for other  
finishes can be found  
here: [Chrome](#)

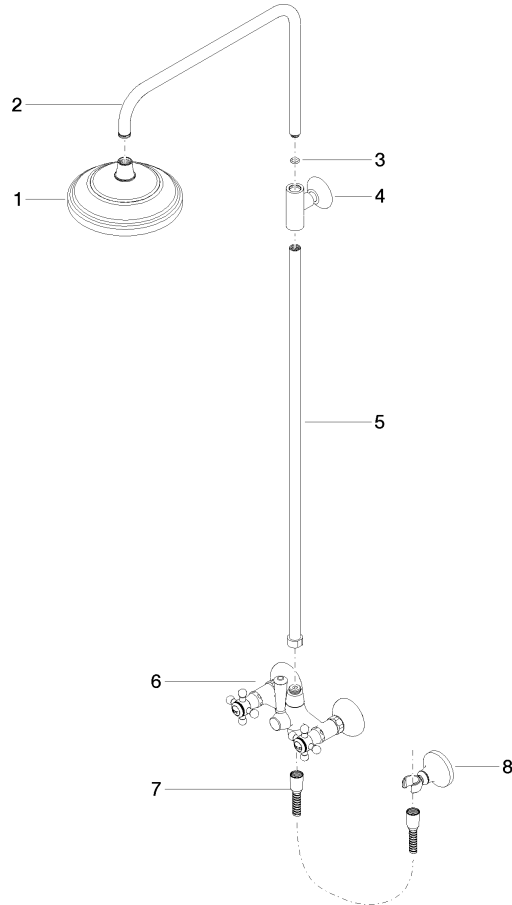



**MADISON Showerpipe with shower mixer without hand shower - Durabrass  
(23kt Gold)**

MADISON

26 632 360

**Spare parts list**

No.	Item Number	Name	Quantity used	Delivery time
	04 12 05 038 01-09	shower	8	60