

**TARA Showerpipe without hand shower FlowReduce 220 mm - Brushed Durabronze (23kt Gold)**

TARA

26 633 892



- shower with fixed riser projection 420mm
- overhead shower: rain flow
- rain shower Ø 220 mm
- rain shower with anti-scale system
- max. rainshower flow 7 l/min
- rotary diverter for fixed-riser shower/hand shower
- height of fittings up to rain shower (bottom edge) 1007mm
- height of fittings up to top edge of elbow 1167mm
- rosette for shower holder Ø 55mm
- rosette for wall mounting Ø 57mm
- rosette for shower mixer Ø 65mm
- gauge 150 mm - 13 mm
- 1500 mm metal shower hose
- 1/2" connection
- Pipe diameter 20 mm
- quick clearing
- This product can help a building meet the requirements of Green Building Rating Systems, e.g. LEED®, BREEAM®, DGNB
- WRAS 2204012

This article does not include a hand shower!

Intrinsic protection against back flow.

	Brushed Durabronze (23kt Gold)	26 633 892-28
	Chrome	26 633 892-00
	Brushed Platinum	26 633 892-06
	Platinum	26 633 892-08
	Dark Chrome	26 633 892-19
	Matte Black	26 633 892-33
	Brushed Bronze	26 633 892-42
	Brushed Champagne (22kt Gold)	26 633 892-46
	Champagne (22kt Gold)	26 633 892-47
	Brushed Chrome	26 633 892-93
	Brushed Dark Platinum	26 633 892-99

TARA Showerpipe without hand shower FlowReduce 220 mm - Brushed Durabross (23kt Gold)

TARA

26 633 892

Required miscellaneous

 **Hand shower - Brushed Durabross (23kt Gold)** 28 015 979-28

Required miscellaneous

 **Hand shower - Brushed Durabross (23kt Gold)** 28 012 979-28

Required miscellaneous

 **Hand shower - Brushed Durabross (23kt Gold)** 28 016 979-28

Required miscellaneous

 **Hand shower FlowReduce - Brushed Durabross (23kt Gold)** 28 016 979-28

Required miscellaneous

 **SERIES-VARIOUS Hand shower - Brushed Durabross (23kt Gold)** 28 029 979-28

Required miscellaneous

 **SERIES-VARIOUS Hand shower - Brushed Durabross (23kt Gold)** 28 027 979-28

Required miscellaneous

 **Hand shower - Brushed Durabross (23kt Gold)** 28 018 979-28

Required miscellaneous

 **Hand shower - Brushed Durabross (23kt Gold)** 28 017 979-28

Required miscellaneous

 **Hand shower FlowReduce - Brushed Durabross (23kt Gold)** 28 012 979-28

Required miscellaneous

 **Hand shower FlowReduce - Brushed Durabross (23kt Gold)** 28 018 979-28

Required miscellaneous

 **SERIES-VARIOUS Hand shower - Brushed Durabross (23kt Gold)** 28 025 979-28



TARA Showerpipe without hand shower FlowReduce 220 mm - Brushed Durabronz (23kt Gold)

TARA

26 633 892

Flow rate chart

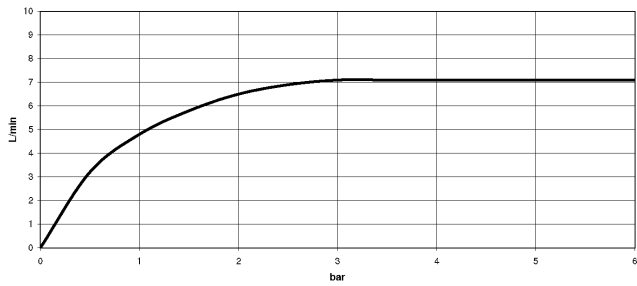

Codes & Standards

DIN 4109

EN 1717

ISO 3822

Scottish Water  
Byelaws

UK Water Supply  
Regulations

Ü-Zeichen



TARA Showerpipe without hand shower FlowReduce 220 mm - Brushed  
Durabross (23kt Gold)

---

TARA

26 633 892

Certificates

---

Belgaqua\_21-023-2 LGA\_38

WRAS\_2204



# TARA Showerpipe without hand shower FlowReduce 220 mm - Brushed Durabronz (23kt Gold)

TARA

26 633 892

**Product version from 4/1/2024**

Parts for other finishes can be found here: [Chrome](#)

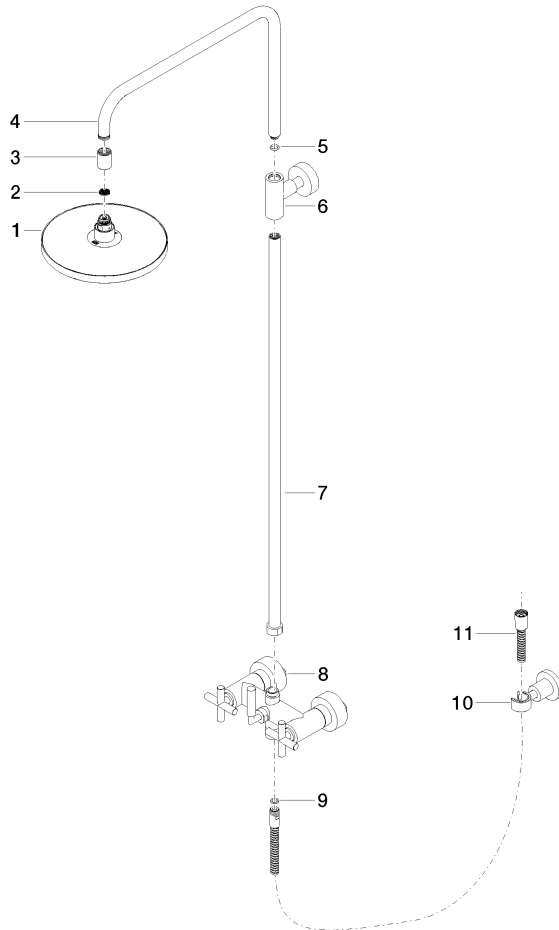



TARA Showerpipe without hand shower FlowReduce 220 mm - Brushed  
Durabross (23kt Gold)

TARA

26 633 892

### Spare parts list

#### Product version from 4/1/2024

No.	Item Number	Name	Quantity used	Delivery time
	90 12 05 092 20-28	shower	11	20