

Rain shower with wall fixing FlowReduce 300 mm - Platinum













TARA

28 678 970



- 450mm projection
- rain shower Ø 300 mm
- PURE RAIN, max. flow rate 9 l/min (at 3 bar)
- Function from: 7 l/min
- rosette Ø 60 mm
- 1/2" connection
- with anti-scale system
- quick clearing
- This product can help a building meet the requirements of Green Building Rating Systems, e.g. LEED®, BREEAM®, DGNB

Fits: TARA, LISSÉ, VAIA, META

	Platinum	28 678 970-08
	Chrome	28 678 970-00
	Brushed Platinum	28 678 970-06
	Dark Chrome	28 678 970-19
	Light Gold	28 678 970-26
	Brushed Light Gold	28 678 970-27
	Brushed Durabronze (23kt Gold)	28 678 970-28
	Matte Black	28 678 970-33
	Brushed Bronze	28 678 970-42
	Brushed Champagne (22kt Gold)	28 678 970-46
	Champagne (22kt Gold)	28 678 970-47
	Brushed Chrome	28 678 970-93
	Brushed Dark Platinum	28 678 970-99

28 678 970

mm [inches]

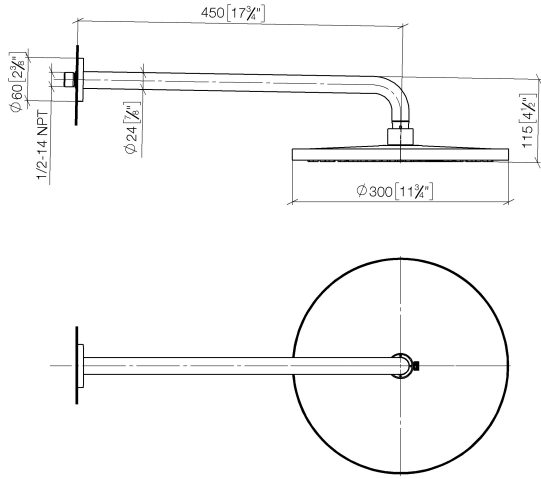

Flow rate chart



Codes & Standards

DIN 4109

ISO 3822

Ü-Zeichen



Rain shower with wall fixing FlowReduce 300 mm - Platinum

TARA

28 678 970

Certificates

LGA_29

28 678 970

Product version from 4/1/2024

Parts for other
finishes can be found
here: [Chrome](#)

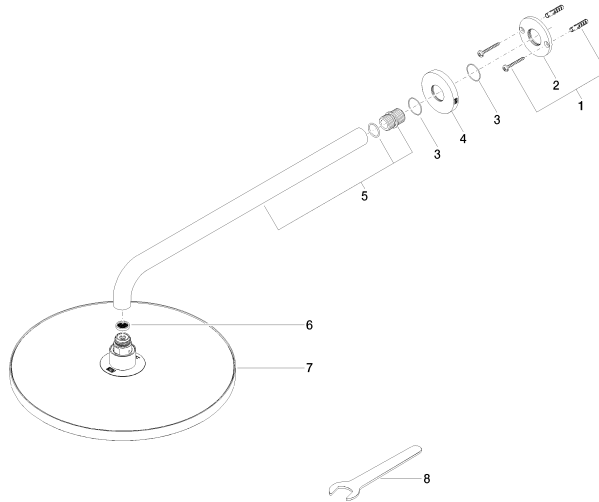



Rain shower with wall fixing FlowReduce 300 mm - Platinum

TARA

28 678 970

Spare parts list

Product version from 4/1/2024

No.	Item Number	Name	Quantity used	Delivery time
	04 30 31 032 00 90	fixing set	9	2