











33 815 861



- 235mm projection
- pivotable spout 360°
- Optional swivel limiter available with swivel limiter set 12 820 970 90
- air-enriched flow
- max. flow 8 l/min at 3 bar flow pressure
- lead-free
- This product can help a building meet the requirements of Green Building Rating Systems, e.g. LEED®, BREEAM®, DGNB
- WRAS 240102021

	Brushed Dark Platinum	33 815 861-99
	Chrome	33 815 861-00
	Brushed Platinum	33 815 861-06
	Platinum	33 815 861-08
	Durabronze (23kt Gold)	33 815 861-09
	Dark Chrome	33 815 861-19
	Brushed Durabronze (23kt Gold)	33 815 861-28
	Matte Black	33 815 861-33
	Brushed Champagne (22kt Gold)	33 815 861-46
	Champagne (22kt Gold)	33 815 861-47
	Brushed Chrome	33 815 861-93

**Recommended miscellaneous**

	<b>Swivel limitation set -</b>	12 820 970 90
---	--------------------------------	---------------

**Recommended miscellaneous**

	<b>Strainer waste with control handle - Brushed Dark Platinum</b>	10 712 970-99
---	---	---------------

**Recommended miscellaneous**

	<b>Dispenser without rosette - Brushed Dark Platinum</b>	82 424 970-99
---	--	---------------

33 815 861

mm [inches]

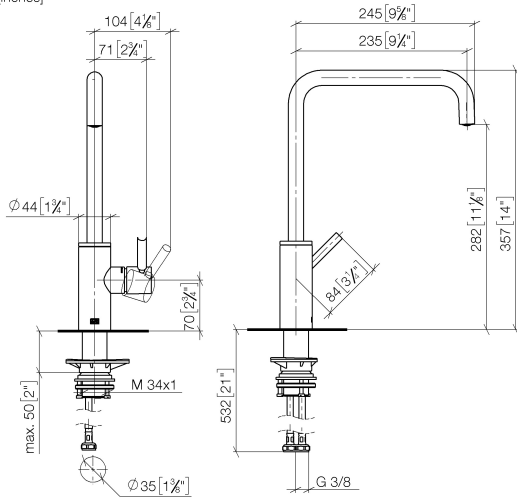

**Flow rate chart**

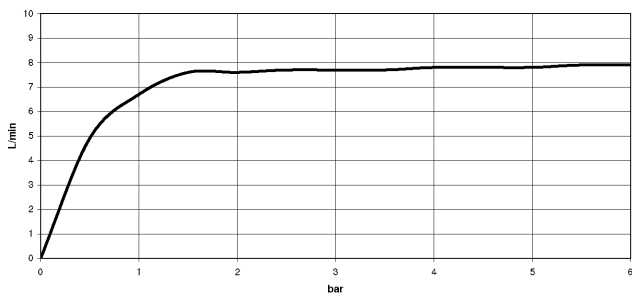

**Codes & Standards**

DIN 4109

ISO 3822

Scottish Water  
Byelaws

UK Water Supply  
Regulations

**Ü-Zeichen**



**META SQUARE Single-lever mixer - Brushed Dark Platinum**

META SQUARE

33 815 861

Certificates

LGA\_38

WRAS\_240102

33 815 861

Product version from 2/1/2023

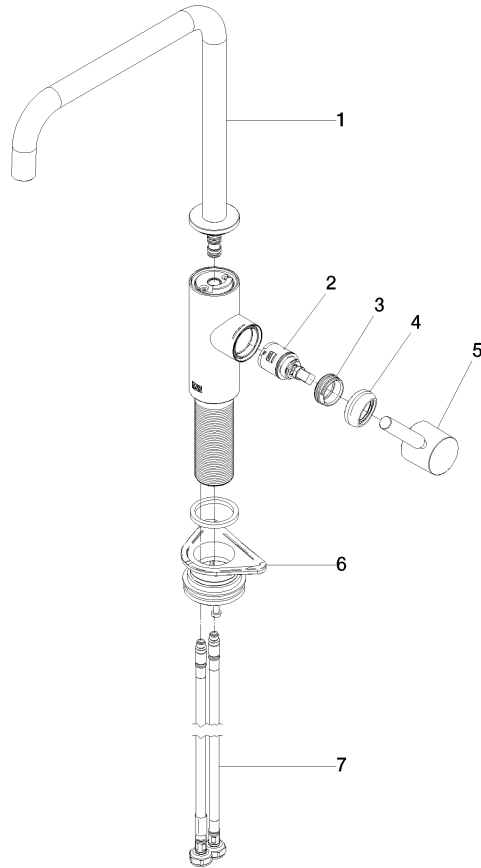



33 815 861

### Spare parts list

#### Product version from 2/1/2023

No.	Item Number	Name	Quantity used	Delivery time
	90 28 22 284 00-99	spout	8	30