





33 816 875



- 241mm projection
- pivotable spout 360°
- air-enriched flow
- height of mixer 393 mm
- height up to aerator 240 mm
- hole diameter 35 mm
- max. flow 8 l/min at 3 bar flow pressure
- lead-free
- This product can help a building meet the requirements of Green Building Rating Systems, e.g. LEED®, BREEAM®, DGNB
- WRAS 2101012

	Brushed Platinum	33 816 875-06
	Chrome	33 816 875-00
	Platinum	33 816 875-08
	Durabronze (23kt Gold)	33 816 875-09
	Dark Chrome	33 816 875-19
	Brushed Durabronze (23kt Gold)	33 816 875-28
	Matte Black	33 816 875-33
	Brushed Champagne (22kt Gold)	33 816 875-46
	Champagne (22kt Gold)	33 816 875-47
	Brushed Chrome	33 816 875-93
	Brushed Dark Platinum	33 816 875-99

Recommended miscellaneous

Strainer waste with control handle - Brushed Platinum 10 712 970-06



Recommended miscellaneous

Dispenser without rosette - Brushed Platinum 82 424 970-06



33 816 875

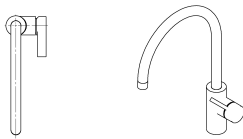
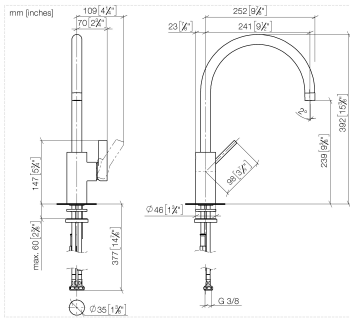

Flow rate chart



Codes & Standards

DIN 4109

EN 817

Executive Order
no. 1007

ISO 3822

Scottish Water
Byelaws

UK Water Supply
Regulations

Ü-Zeichen

VA-Zeichen



TARA ULTRA Single-lever mixer - Brushed Platinum

TARA ULTRA

33 816 875

Certificates

GDV_0400

LGA_18

WRAS_2101

ETA_18

33 816 875

Product version from 5/31/2010 to 7/25/2018

Product version from 7/25/2018 to 5/15/2020

Product version from 5/15/2020 to 10/27/2020

Product version from 10/27/2020 to 5/3/2021

Product version from 5/3/2021

Product version from 6/1/2022

Parts for other finishes can be found here: [Chrome](#)

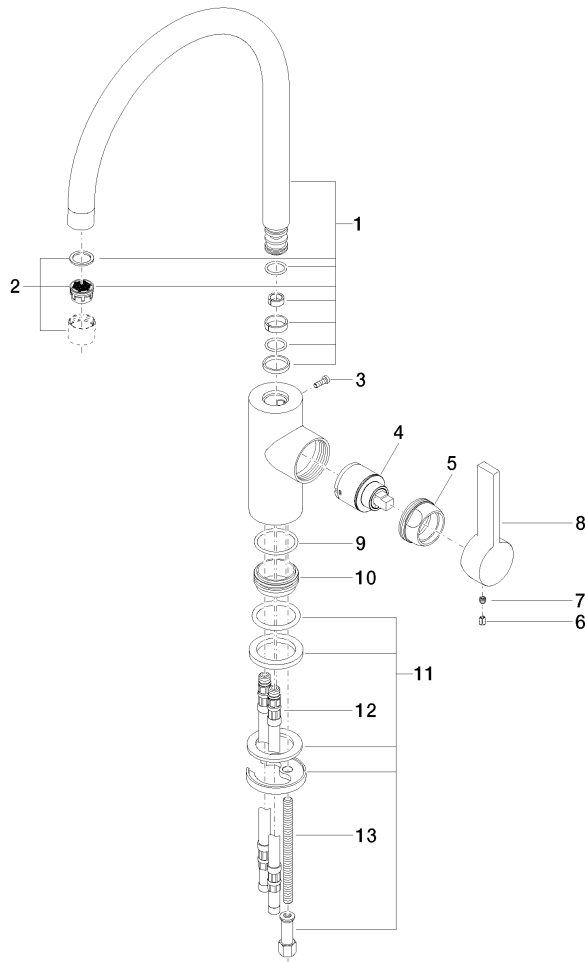



TARA ULTRA Single-lever mixer - Brushed Platinum

TARA ULTRA

33 816 875

Spare parts list

Product version from 5/31/2010 to 7/25/2018

Product version from 7/25/2018 to 5/15/2020

Product version from 5/15/2020 to 10/27/2020

Product version from 10/27/2020 to 5/3/2021

Product version from 5/3/2021

Product version from 6/1/2022

No.	Item Number	Name	Quantity used	Delivery time
	90 28 22 202 02-06	spout	14	10