







**TARA ULTRA Profi single-lever mixer - Dark Chrome**

33 860 875



- 240mm projection
- pivotable 360°
- air-enriched flow and spray flow
- height of mixer 685 mm
- height up to aerator 129 mm
- hole diameter 35 mm
- sprayface with anti-scaling system
- max. flow 8 l/min at 3 bar flow pressure
- lead-free
- This product can help a building meet the requirements of Green Building Rating Systems, e.g. LEED®, BREEAM®, DGNB

Intrinsic protection against back flow.

	Dark Chrome	33 860 875-19
	Chrome	33 860 875-00
	Brushed Platinum	33 860 875-06
	Platinum	33 860 875-08
	Brushed Bronze	33 860 875-42
	Brushed Chrome	33 860 875-93
	Brushed Dark Platinum	33 860 875-99

**Recommended miscellaneous**

**Dispenser without rosette - Dark Chrome** 82 424 970-19



**Recommended miscellaneous**

**Strainer waste with control handle - Dark Chrome** 10 712 970-19



**TARA ULTRA Profi single-lever mixer - Dark Chrome**

33 860 875

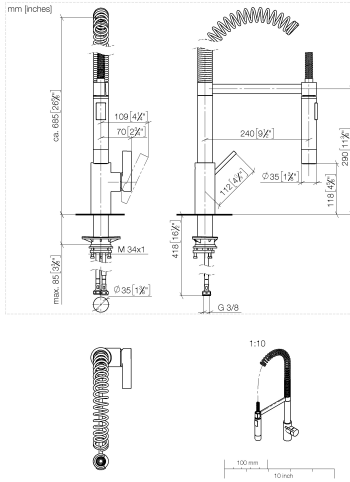

**Flow rate chart**

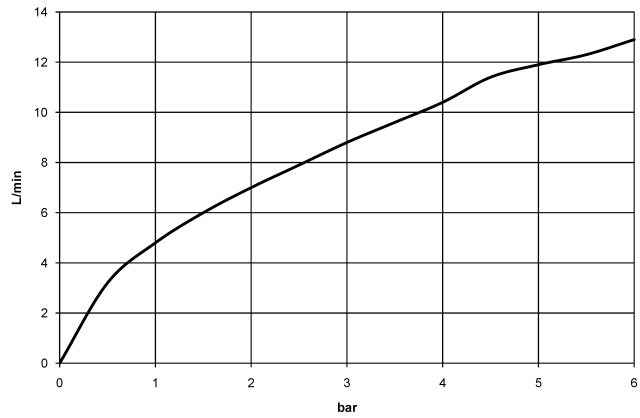

**Codes & Standards**

DIN 4109

EN 1717

ISO 3822

Ü-Zeichen



## TARA ULTRA Profi single-lever mixer - Dark Chrome

---

33 860 875

### Certificates

---

LGA\_18

Belgaqua\_22\_277\_2

**TARA ULTRA Profi single-lever mixer - Dark Chrome**

33 860 875

Parts for other finishes can be found here: [Chrome](#)

