

Concealed single-lever mixer with integrated shower connection with hand shower set without hand shower - Brushed Platinum

IMO

36 002 970



- metal shower hose 1750mm with integrated anti-twist protection
- WRAS 2011027













This article does not include a hand shower!

Intrinsic protection against back flow.

This article does not include a hand shower!

Intrinsic protection against back flow.

Fits: IMO, LULU, MADISON, MEM, TARA, CL.1, LISSÉ, VAIA, META, CYO

	Brushed Platinum	36 002 970-06
	Chrome	36 002 970-00
	Platinum	36 002 970-08
	Dark Chrome	36 002 970-19
	Brushed Light Gold	36 002 970-27
	Brushed Durabronze (23kt Gold)	36 002 970-28
	Matte Black	36 002 970-33
	Brushed Bronze	36 002 970-42
	Brushed Champagne (22kt Gold)	36 002 970-46
	Champagne (22kt Gold)	36 002 970-47
	Brushed Chrome	36 002 970-93
	Brushed Dark Platinum	36 002 970-99

Concealed single-lever mixer with integrated shower connection with hand shower set without hand shower - Brushed Platinum

IMO

36 002 970

Required miscellaneous



Concealed wall mounting -
 ●max. recess depth 105 mm
 ●min. recess depth 80 mm

35 050 970 90

Required miscellaneous



Hand shower - Brushed Platinum 28 012 979-06

Required miscellaneous



**Hand shower FlowReduce -
 Brushed Platinum**

28 016 979-06
 0010

Required miscellaneous



Hand shower - Brushed Platinum 28 017 979-06

Required miscellaneous



**Hand shower FlowReduce -
 Brushed Platinum**

28 012 979-06
 0010

Required miscellaneous



Hand shower - Brushed Platinum 28 016 979-06

Required miscellaneous



Hand shower - Brushed Platinum 28 018 979-06

Required miscellaneous



**Hand shower FlowReduce -
 Brushed Platinum** 28 018 979-06
 0010

Required miscellaneous



**SERIES-VARIOUS Hand shower -
 Brushed Platinum** 28 029 979-06
 0010

Required miscellaneous



**SERIES-VARIOUS Hand shower -
 Brushed Platinum** 28 029 979-06

Required miscellaneous



**SERIES-VARIOUS Hand shower -
 Brushed Platinum** 28 027 979-06
 0010

Required miscellaneous



**SERIES-VARIOUS Hand shower -
 Brushed Platinum** 28 025 979-06
 0010

Concealed single-lever mixer with integrated shower connection with hand shower set without hand shower - Brushed Platinum

IMO

36 002 970
mm [inches]

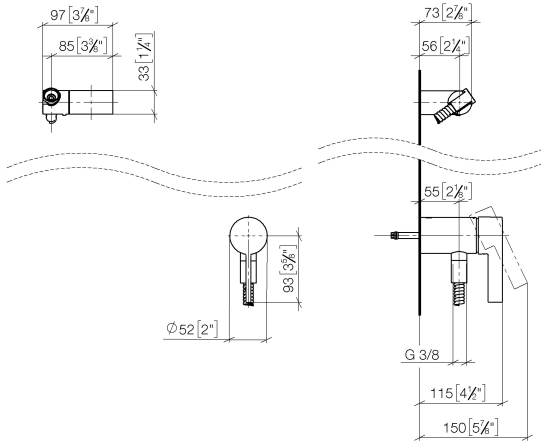

Codes & Standards

DIN 4109

EN 1717

ISO 3822

Scottish Water
Byelaws

UK Water Supply
Regulations

Ü-Zeichen

Certificates

Belgaqua_21-025-2 WRAS_2011

LGA_29

Concealed single-lever mixer with integrated shower connection with hand shower set without hand shower - Brushed Platinum

36 002 970

Product version from 10/1/2023

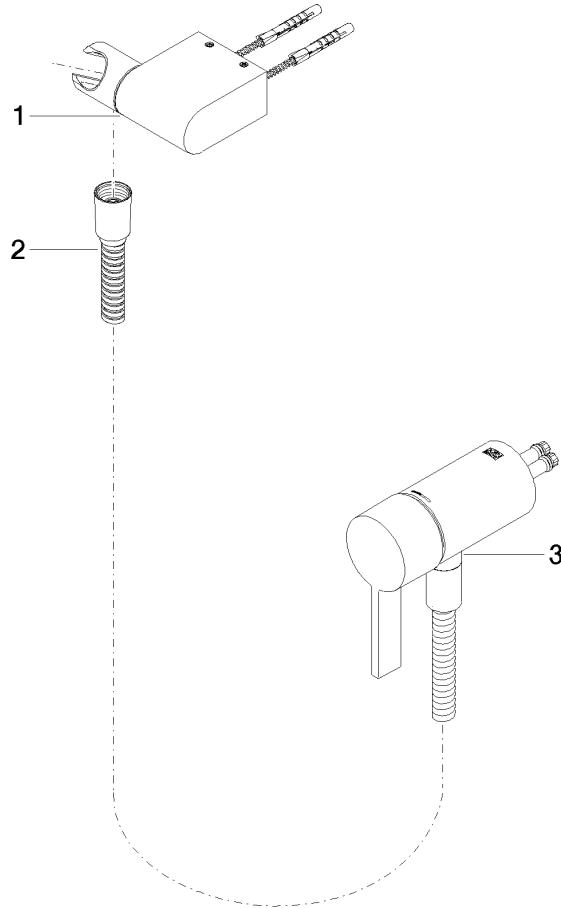



Concealed single-lever mixer with integrated shower connection with hand shower set without hand shower - Brushed Platinum

IMO

36 002 970

Spare parts list

Product version from 10/1/2023

No.	Item Number	Name	Quantity used	Delivery time
	28 060 970-06	Wall bracket swivel - Brushed Platinum	3	10