

Showerpipe with single-lever shower mixer without hand shower - Brushed Platinum

IMO

36 112 970















Fits: IMO, LULU, TARA, LISSÉ, VAIA, META

- shower with fixed riser projection 450mm
- overhead shower: rain flow
- rain shower Ø 220 mm
- rain shower with anti-scale system
- max. rainshower flow 14 l/min
- height of fittings up to rain shower (bottom edge) 1010mm
- height of fittings up to top edge of elbow 1150mm
- metal shower hose 1750mm with integrated anti-twist protection
- 1/2" connection
- slide bar
- Pipe diameter 23.5 mm
- automatic diverter for fixed-riser shower/hand shower
- quick clearing
- WRAS 2101043

This article does not include a hand shower!
Intrinsic protection against back flow.

This article does not include a hand shower!
Intrinsic protection against back flow.

	Brushed Platinum	36 112 970-06
	Chrome	36 112 970-00
	Platinum	36 112 970-08
	Dark Chrome	36 112 970-19
	Brushed Light Gold	36 112 970-27
	Brushed Durabronze (23kt Gold)	36 112 970-28
	Matte Black	36 112 970-33
	Brushed Bronze	36 112 970-42
	Brushed Champagne (22kt Gold)	36 112 970-46
	Champagne (22kt Gold)	36 112 970-47
	Brushed Chrome	36 112 970-93
	Brushed Dark Platinum	36 112 970-99

Showerpipe with single-lever shower mixer without hand shower - Brushed Platinum

IMO

36 112 970

Required miscellaneous



Concealed wall mounting -
 ●max. recess depth 105 mm
 ●min. recess depth 80 mm

35 050 970 90

Required miscellaneous



Hand shower - Brushed Platinum 28 012 979-06

Required miscellaneous



**Hand shower FlowReduce -
 Brushed Platinum**

28 016 979-06
 0010

Required miscellaneous



Hand shower - Brushed Platinum 28 017 979-06

Required miscellaneous



**Hand shower FlowReduce -
 Brushed Platinum**

28 012 979-06
 0010

Required miscellaneous



Hand shower - Brushed Platinum 28 016 979-06

Required miscellaneous



Hand shower - Brushed Platinum 28 018 979-06

Required miscellaneous



**Hand shower FlowReduce -
 Brushed Platinum** 28 018 979-06
 0010

Required miscellaneous



**SERIES-VARIOUS Hand shower -
 Brushed Platinum** 28 029 979-06
 0010

Required miscellaneous



**SERIES-VARIOUS Hand shower -
 Brushed Platinum** 28 029 979-06

Required miscellaneous



**SERIES-VARIOUS Hand shower -
 Brushed Platinum** 28 027 979-06
 0010

Required miscellaneous



**SERIES-VARIOUS Hand shower -
 Brushed Platinum** 28 025 979-06
 0010

Showerpipe with single-lever shower mixer without hand shower - Brushed Platinum

IMO

36 112 970
mm [inches]
1:10

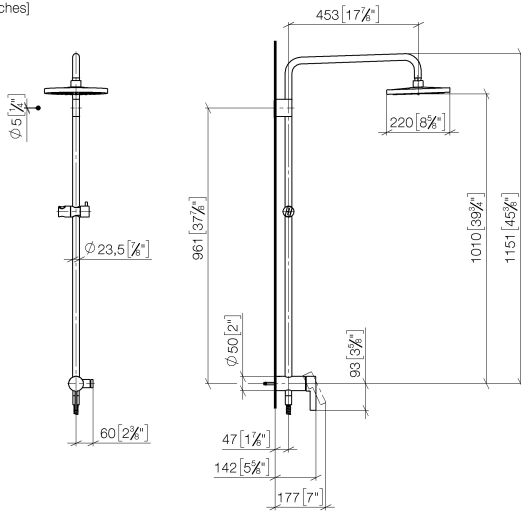

Flow rate chart

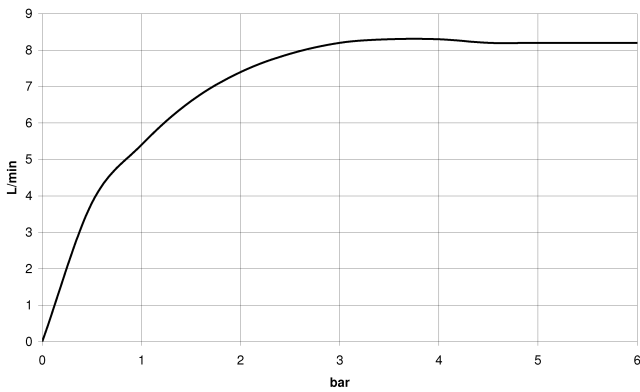

Codes & Standards

DIN 4109

EN 1717

EN 817

ISO 3822

Scottish Water
Byelaws

UK Water Supply
Regulations

Ü-Zeichen



Showerpipe with single-lever shower mixer without hand shower - Brushed
Platinum

IMO

36 112 970

Certificates

DVGW_DW-
6512DN0

Belgaqua_21-025-2 LGA_38

WRAS_2101

36 112 970

Product version from 4/1/2024

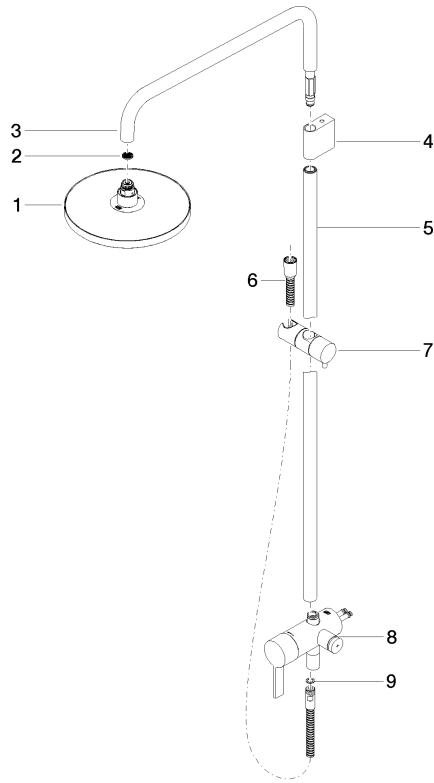



Showerpipe with single-lever shower mixer without hand shower - Brushed
Platinum

IMO

36 112 970

Spare parts list

Product version from 4/1/2024

No.	Item Number	Name	Quantity used	Delivery time
	04 12 05 092 00-06	shower	9	10