

WATER FAN vertical Concealed body spray - Platinum









IMO

36 513 979



- AQUAPRESSURE FLOW, max. flow rate 10 l/min (at 3 bar)
- water jet adjustable
- cover plate 240 x 60 mm
- 1/2" connection
- WRAS 2005003

Fits: IMO, LULU, MADISON, MEM, TARA, CL.1, LISSÉ, VAIA, META, CYO

	Platinum	36 513 979-08
	Chrome	36 513 979-00
	Brushed Platinum	36 513 979-06
	Dark Chrome	36 513 979-19
	Light Gold	36 513 979-26
	Brushed Light Gold	36 513 979-27
	Brushed Durabronze (23kt Gold)	36 513 979-28
	Matte Black	36 513 979-33
	Brushed Bronze	36 513 979-42
	Brushed Champagne (22kt Gold)	36 513 979-46
	Champagne (22kt Gold)	36 513 979-47
	Brushed Chrome	36 513 979-93
	Brushed Dark Platinum	36 513 979-99

Required miscellaneous

- | | | |
|---|--|---------------|
|  | Concealed wall installation box - | 35 206 970 90 |
| | • max. recess depth 173 mm | |
| | • min. recess depth 100 mm | |

Recommended miscellaneous

- | | | |
|---|--|---------------|
|  | xGRID Attachment set for integrating in the dry wall construction - | 12 340 970 90 |
|---|--|---------------|

Required miscellaneous

- | | | |
|---|--|---------------|
|  | xGRID Installation track 555 mm - | 12 360 970 90 |
|---|--|---------------|

36 513 979

mm [inches]



Flow rate chart



Trajectory diagram

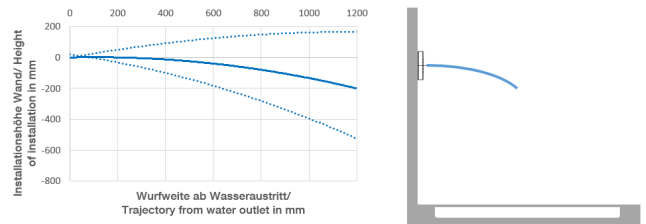

Codes & Standards

DIN 4109

ISO 3822

Scottish Water
Byelaws

UK Water Supply
Regulations

Ü-Zeichen



WATER FAN vertical Concealed body spray - Platinum

IMO

36 513 979

Certificates

LGA_29

WRAS_2005

36 513 979

Product version from 4/1/2024

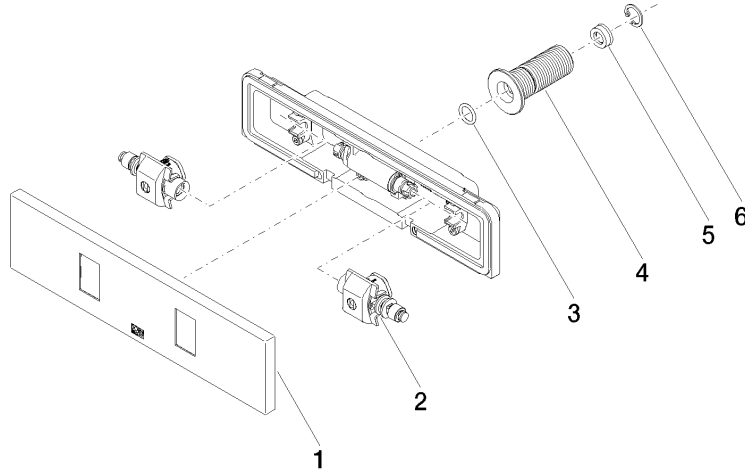



WATER FAN vertical Concealed body spray - Platinum

IMO

36 513 979

Spare parts list

Product version from 4/1/2024

No.	Item Number	Name	Quantity used	Delivery time
	90 27 99 002 00-08	insert	6	40