











36 514 979



- AQUAPRESSURE FLOW, max. flow rate 10 l/min (at 3 bar)
- water jet adjustable
- cover plate 120 x 60 mm
- 1/2" connection
- WRAS 2005004

Fits: IMO, LULU, MADISON, MEM, TARA, CL.1, LISSÉ, VAIA, META, CYO

	Chrome	36 514 979-00
	Brushed Platinum	36 514 979-06
	Platinum	36 514 979-08
	Dark Chrome	36 514 979-19
	Light Gold	36 514 979-26
	Brushed Light Gold	36 514 979-27
	Brushed Durabronze (23kt Gold)	36 514 979-28
	Matte Black	36 514 979-33
	Brushed Bronze	36 514 979-42
	Brushed Champagne (22kt Gold)	36 514 979-46
	Champagne (22kt Gold)	36 514 979-47
	Brushed Chrome	36 514 979-93
	Brushed Dark Platinum	36 514 979-99

**Recommended miscellaneous**



- Concealed wall elbow -** 35 085 970 90
- max. recess depth 163 mm
  - min. recess depth 90 mm

36 514 979

mm [inches]



**Flow rate chart**

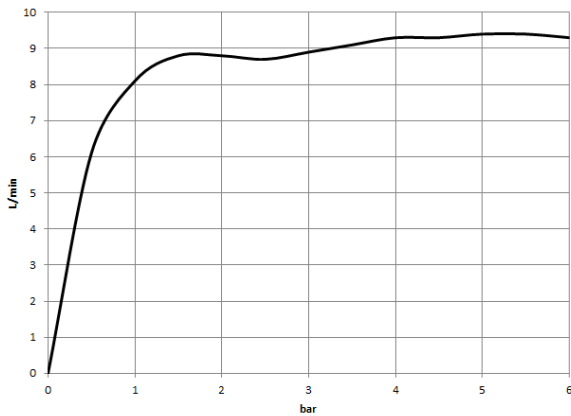

**Trajectory diagram**

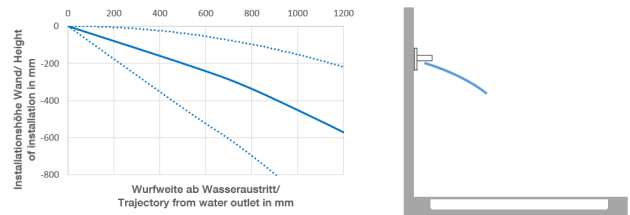

**Codes & Standards**

DIN 4109

ISO 3822

Scottish Water  
Byelaws

UK Water Supply  
Regulations

Ü-Zeichen



WATER CURVE Concealed body spray - Chrome

IMO

36 514 979

Certificates

LGA\_29

WRAS\_2005

36 514 979

Product version from 4/1/2024

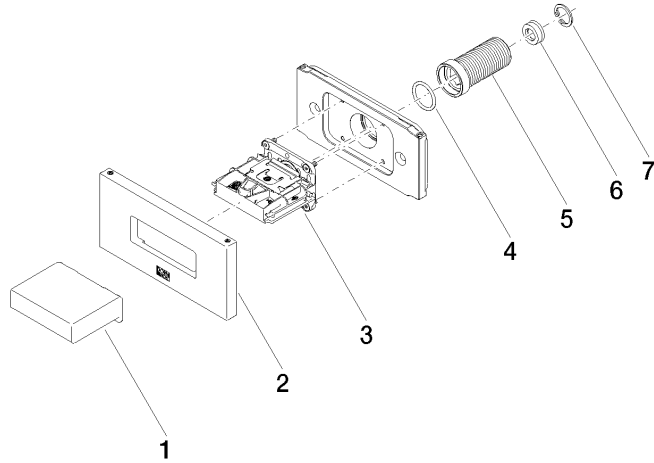



WATER CURVE Concealed body spray - Chrome

IMO

36 514 979

**Spare parts list**

**Product version from 4/1/2024**

No.	Item Number	Name	Quantity used	Delivery time
	09 17 01 230-00	casing	7	10