







**CL.1 Wall valve clockwise closing cold 1/2" - Chrome**

CL.1

36 607 706



- rosette 60 x 60 mm
- with cold marking
- head part with cut-to-length spindle and sleeve
- WRAS 2010066

	Chrome	36 607 706-00
	Brushed Platinum	36 607 706-06
	Dark Chrome	36 607 706-19
	Brushed Champagne (22kt Gold)	36 607 706-46
	Champagne (22kt Gold)	36 607 706-47
	Brushed Dark Platinum	36 607 706-99

**Required miscellaneous**



**Wall valve 1/2" -**

35 607 970 90

- max. recess depth 150 mm
- min. recess depth 105 mm

36 607 706

mm [inches]



**Codes & Standards**

ASME A112.18.1	cUPC	DIN 4109	EN 200
ISO 3822	Scottish Water Byelaws	UK Water Supply Regulations	Ü-Zeichen

**Certificates**

IAPMO_4976	DVGW_DW-6501DN0	WRAS_2010	LGA_29	LGA_29
------------	-----------------	-----------	--------	--------

36 607 706

Product version up to 10/14/2020

**Product version from 10/14/2020**

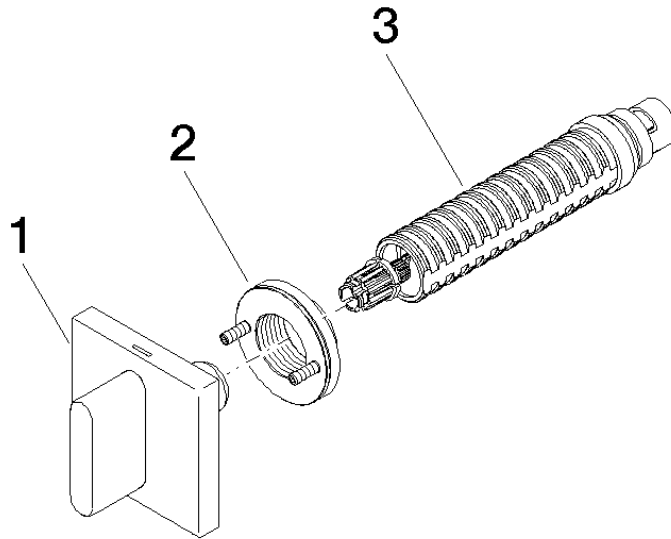



## CL.1 Wall valve clockwise closing cold 1/2" - Chrome

CL.1

36 607 706

### Spare parts list

Product version up to 10/14/2020

### Product version from 10/14/2020

No.	Item Number	Name	Quantity used	Delivery time
	90 20 70 051 02-00	handle ( cold )	3	10