







CL.1 Wall valve anti-clockwise closing hot 1/2" - Chrome

CL.1

36 607 707



- rosette 60 x 60 mm
- with hot marking
- head part with cut-to-length spindle and sleeve
- WRAS 2010066

	Chrome	36 607 707-00
	Brushed Platinum	36 607 707-06
	Dark Chrome	36 607 707-19
	Brushed Champagne (22kt Gold)	36 607 707-46
	Champagne (22kt Gold)	36 607 707-47
	Brushed Dark Platinum	36 607 707-99

Required miscellaneous



Wall valve 1/2" -

35 607 970 90

- max. recess depth 150 mm
- min. recess depth 105 mm



CL.1 Wall valve anti-clockwise closing hot 1/2" - Chrome

CL.1

36 607 707

mm [inches]

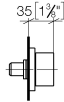

Codes & Standards

ASME A112.18.1

cUPC

DIN 4109

EN 200

ISO 3822

Scottish Water
Byelaws

UK Water Supply
Regulations

Ü-Zeichen

Certificates

IAPMO_4976

DVGW_DW-
6501DN0

WRAS_2010

LGA_29

LGA_29

36 607 707

Product version up to 10/14/2020

Product version from 10/14/2020

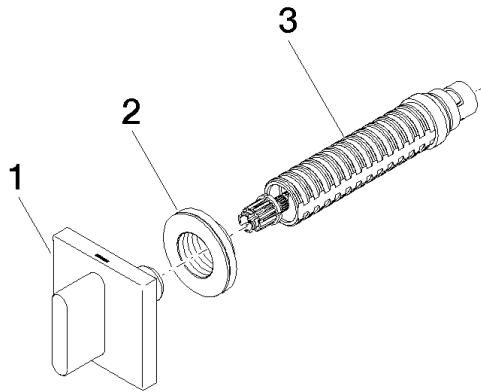



CL.1 Wall valve anti-clockwise closing hot 1/2" - Chrome

CL.1

36 607 707

Spare parts list

Product version up to 10/14/2020

Product version from 10/14/2020

No.	Item Number	Name	Quantity used	Delivery time
	90 20 70 051 03-00	handle (hot)	3	10